

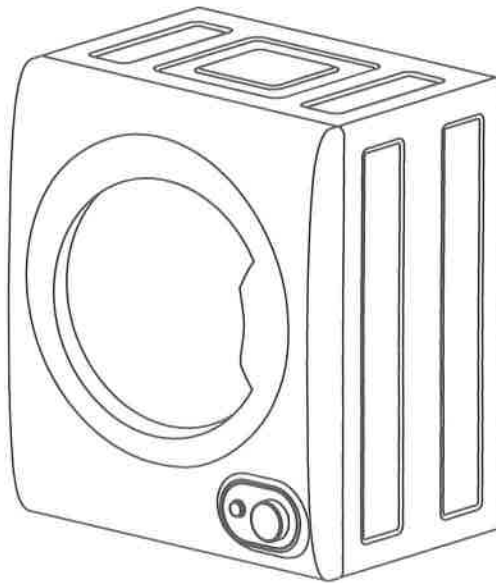

INSTRUCTION MANUAL

Model Number : D110J2P-IS

CLOTHES DRYER



CAUTION:

BEFORE USE, PLEASE READ AND FOLLOW ALL SAFETY RULES AND OPERATING INSTRUCTIONS.

Avanti has a policy of continuous improvement on its products and reserves the right to change materials and specifications without notice.

Avanti Products
P.O. Box 520604 - Miami, Florida 33172
www.avantiproducs.com

TABLE OF CONTENTS

Help Us Help You	3
Parts and Features	4
Important Safety Instructions	5
Installation Instructions	5
Before Using Your Dryer	5
Wall Mounting Instructions	6
Leveling Legs	7
Electrical Connection	7
Control Panel	7
Operating Your Appliance	8
Temperature Control	8
Dry Mode Selector	8
Drying Time Reference	8
Sorting Fabrics	9
Fabric Care Sheet	10
Care and Maintenance	11
Cleaning Your Appliance Exterior	11
Cleaning the Filters	11
Troubleshooting Guide	12
Service for Your Appliance	12
Your Avanti Products Warranty	13
Registration Information and Registration Card	15

HELP US HELP YOU...

Read this guide carefully.

It is intended to help you operate and maintain your new appliance properly.

Keep it handy to answer your questions.

If you don't understand something or your need more help, please call:

Avanti Customer Service
800-220-5570

Keep proof of original purchase date (such as your sales slip) with this guide to establish the warranty period.

Write down the model and serial numbers.

You'll find them on a plate located on the back wall of the appliance.

Please write these numbers here:

Date of Purchase

Model Number

Serial Number

Use these numbers in any correspondence or service calls concerning your appliance.

If you received a damaged appliance, immediately contact the dealer (or builder) that sold you the appliance.

Save time and money. Before you call for service, check the Troubleshooting Guide. It lists causes of minor operating problems that you can correct yourself.

IF YOU NEED SERVICE

We're proud of our service and want you to be pleased. If for some reason you are not happy with the service you receive, here are some steps to follow for further help.

FIRST, contact the people who serviced your appliance. Explain why you are not pleased. In most cases, this will solve the problem.

NEXT, if you are still not pleased, write all the details, including your telephone number, and send to:

Customer Service
Avanti Products
10880 NW 30 Street
Miami, FL 33172

PARTS AND FEATURES

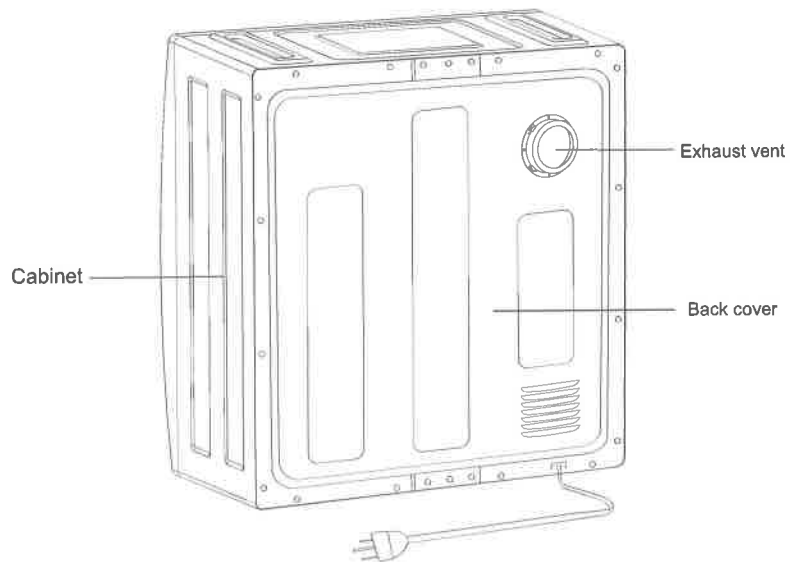
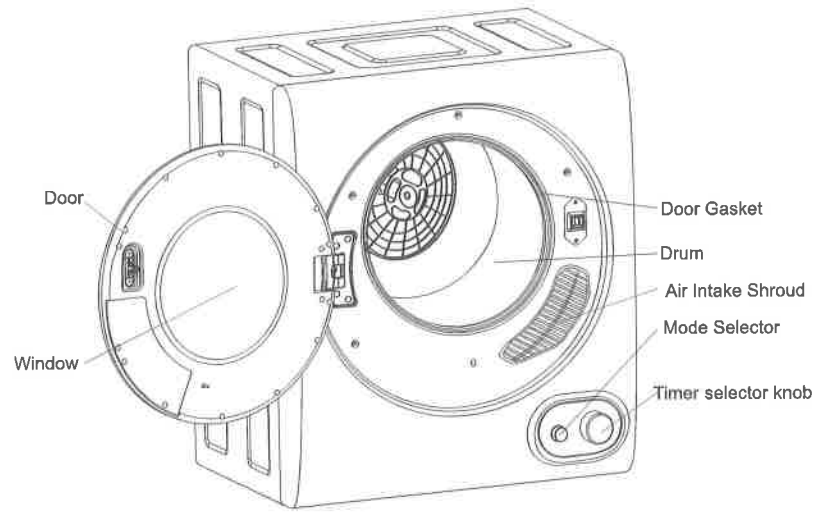

Important Safety Instructions

⚡ WARNING ⚡

To reduce the risk of fire, electrical shock, or injury when using your appliance, follow these basic precautions:

- Read all instructions before using the appliance.
- **DANGER or WARNING:** Risk of child entrapment.
- Child entrapment and suffocation are not problems of the past. Junked or abandoned appliances are still dangerous. . . even if they will “just sit in the garage a few days.”
- **Before you throw away your old appliance:** Take off the door so that children may not easily climb inside.
- Never allow children to operate, play with, or crawl inside the appliance.
- Never clean appliance parts with flammable fluids. The fumes can create a fire hazard or explosion.
- Do not place the dryer in steamy rooms or where the dryer is directly exposed to rain. Moisture may destroy the electrical insulation causing an electrical shock hazard.
- During spinning, don't put your hand in the spin basket: Because the spin basket is rotating at high speed, rotating parts may injure your hand.
- Do not store or use gasoline or any other flammable vapors and liquids in the vicinity of this or any other appliance. The fumes can create a fire hazard or explosion.

-Save these instructions-

INSTALLATION INSTRUCTIONS

➤ **Before Using Your Appliance**

- Remove the exterior and interior packing.
- Check to be sure you have all of the following parts:
 - Instruction Manual
 - Allow at least 5 inches of space between the sides of the appliance.
 - Put your laundry into the dryer evenly. Uneven laundry may cause noise or vibration.
 - Before drying, check all pockets. If nails or pins remain in pockets, they may damage the dryer or clothes.
 - Never splash water on the control panel.
 - Plug the dryer into an exclusive properly installed-grounded wall outlet. Do not under any circumstances cut or remove the third (ground) prong from the power cord. Any questions concerning power and or grounding should be directed toward a certified electrician or an authorized Avanti Products service center.

➤ **Selecting a Location**

Before you install the dryer, select a location with the following characteristics:

- A hard level surface (if the surface is uneven, see “Adjusting the Leveling Legs”).
- If you are going to wall mount your dryer using the wall mounting kit included (see “Wall Mounting Instructions”)
- Away from direct sunlight. Direct sunlight may affect the acrylic coating, plastic and electrical components.
- Adequate ventilation
- Room temperature that will not fall below 0°C.
- Away from sources of heat such as coal or gas. Make sure that the dryer does not stand on its power cord. Ventilation openings must not be obstructed by carpeting when the dryer is installed on a carpeted floor.

➤ **Wall Mounting Instructions**

**** It is recommended to complete the following procedure with at least 2 people ****

Tools Required		
Tools and parts required for Plaster and or Wood Installation	Drill & Drill Bit	1
	Phillips Head Screw Driver	1
	Wood screws 2" long	4
Wall Mounting Kit Includes the following:		
Description	Wall Hanging Bracket	2
	Wall Hanging Hook	2
	Plastic Spacers	2
	Exhaust Pipe	1

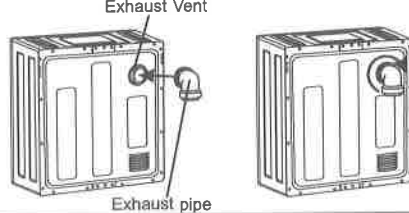
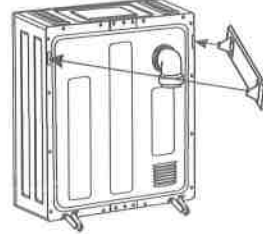
a)	<p>Determine the position where you will be installing the mounting bracket. (This dryer is not designed to sit directly on top of your washing machine).</p> <p>(A minimum of 2 inches is required between the top of the dryer and the ceiling to allow easy installation and adequate space for exhaust).</p> <p>(If mounting above a washing machine, allow sufficient spacing to open the lid of the washer or breathing room in the case of a front loading washer).</p>	
b)	<p>Affix the wall mounting bracket (included) securely to the wall (directly to the stud).</p> <p>(If a stud is not available, use a wooden slat between the studs to mount the bracket)</p>	<p>Fig 2</p>  <p>Labels: Wall Hanging Hook, 25mm long Screws, Timber(not included)</p>
c)	<p>Install the Wall Hanging Hooks as shown in illustration (Fig. 2).</p>	
d)	<p>Install the exhaust pipe as shown in illustration (Fig. 3). (Align the Exhaust pipe to the Exhaust Vent and turn Clockwise)</p> <ul style="list-style-type: none"> The exhaust vent can be locked into the position that best fits your needs. (Upward, Downward or venting to either side left or right). 	<p>Fig 3</p>  <p>Labels: Exhaust Vent, Exhaust pipe</p>
e)	<p>Mount the dryer on the wall bracket as shown in illustration (Fig. 4).</p> <p>** It is recommended that this step be done by two (2) or more persons **</p>	<p>Fig 4</p> 

➤ **Adjusting the leveling legs**

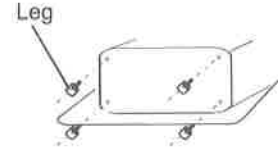

Your dryer is shipped with the legs in the bag containing your user's guide. To install and adjust the leveling legs see the illustration to the right.

If the floor is uneven adjust the legs (do not insert pieces of wood, or any other objects under the legs)

- Adjust the height level of the legs accordingly.

Place the dryer on a sturdy flat surface.

If the dryer is placed on an uneven or weak surface, noise or vibration will occur. (Allowable is 1°)

➤ **Electrical Connection**

⚡ Warning ⚡

Improper use of the grounded plug can result in the risk of electrical shock. If the power cord is damaged, have it replaced by an authorized Avanti Products service center.

This appliance should be properly grounded for your safety. The power cord of this appliance is equipped with a three-prong plug which mates with standard three prong wall outlets to minimize the possibility of electrical shock.

Do not under any circumstances cut or remove the third ground prong from the power cord supplied.

Use of extension cord is not recommended.

This appliance requires a standard 115/120-volt, 60Hz electrical outlet with three-prong ground. The cord should be secured behind the appliance and not left exposed or dangling to prevent accidental injury.

➤ **CONTROL PANEL**



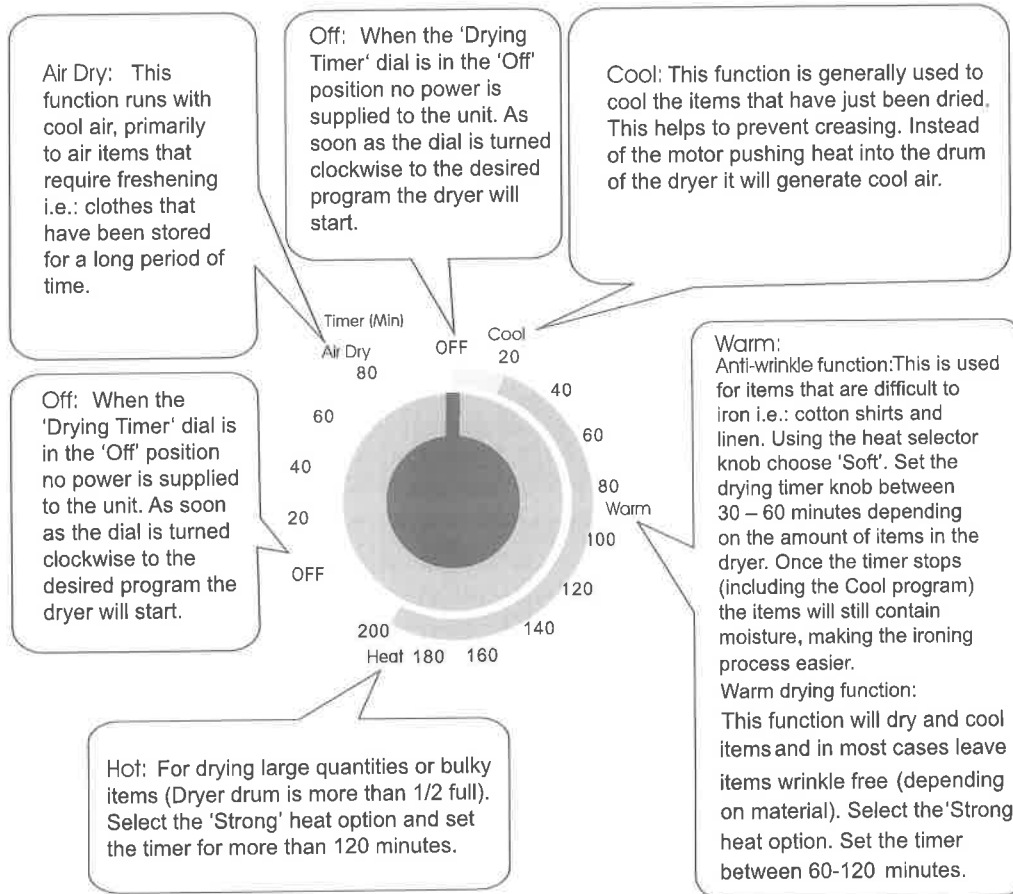

➤ OPERATING INSTRUCTIONS

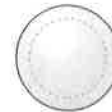

➤ DRY MODE SELECTOR

This unit is designed with an automatic moisture sensor to monitor the moisture level of the clothes for optimistic performance. It provides you both **Auto Dry** and **Timed Dry** modes for your best drying performance.



 Auto Dry
 Timed Dry

Auto Dry Mode:

When the selector button is up, unit works at automatic drying mode. Please set the timer to 200 minutes and unit will start drying process till the moisture reaches setting degree, (unit will cut off the heating element inside and terminate the drying automatically), but unit will continue the wrinkle guard process till the timer runs to "OFF" position.

Note: For heavy items like jeans, blankets, covers, towels, etc., recommended mode is timed dry.

Timed Dry Mode:

When the selector button is pressed down, unit will work under timer controlled mode. Set the timer with the following references:

➤ **DRYING TIME REFERENCE**

**** LOAD WEIGHTS AND RESPECTIVE DRYING TIMES ARE APPROXIMATE ****

Drying Capacity	Drying Times	
	High Heat	Low Heat
3 (Three) Lbs	30 Minutes	55 Minutes
5 (Five) Lbs	60 Minutes	110 Minutes
7 (Seven) Lbs	120 Minutes	
9 (Nine) Lbs	200 Minutes	

Sorting Fabrics

For the best drying results, clothes should be sorted properly. Separate the lint shedders (chenille and terry cloth) from the lint collectors (synthetics, flannel and fabrics with a nap, such as velveteen and corduroy). Separate non-colorfast from light colored items, heavy fabrics from light weight fabrics and permanent press from heavy, bulky items.

Do not tumble dry

Read all permanent care labels carefully. If a garment's care label says "Drip Dry", Line Dry or "Dry Flat", do not dry in the dryer. Certain materials will melt or become dangerously flammable if heated, while others may lose their shape. Other items that should not be tumble dried are:

- Items that have been dry-cleaned at home.
- Wool (unless the garment's manufacturer recommends it)
- Fiberglass
- Laminated or rubber coated items
- Vinyl or plastic
- Do not use fabric softeners or products to eliminate static unless recommended by manufacturer of the fabric softener or product.

WARNING:

To reduce the risk of fire, electric shock, or injury to persons, read the IMPORTANT SAFETY INSTRUCTIONS before operating this appliance.

Drying Time

Drying time depends on many factors, such as the amount of washing, how damp it is, the type of fabrics, rated power of the machine and the temperature of the room. It also, of course, depends on how dry you want the washing when you take it out of the machine.

Shrinkage

Knitted fabrics in particular are liable to shrink. Do not use the extra dry program for these materials, and always stretch them out directly after drying.

Dryer Added Fabric Softeners

Because some dryer added fabric softeners may cause damage to automatic dryers, use only ones that the manufacturers give a written assurance that their softeners can safely be used in your dryer.

Single Items

Use the timed program when there is only one item to be dried. This is because the automatic program may turn off the heating too early, so that the item is not properly dried.

If The Washing Is Not Dry After Tumble-Drying

























When using the automatic programs, it can happen that not all of the washing is properly dry. This may be due

to such reasons as very heavy fabrics or thick seams. To dry these items, give a further 10 minutes or so in the timed program. Also do not overload the dryer. If the dryer is overloaded, its efficiency is lessened and clothes may not dry evenly.

Do not over-dry

When using the timed program, it is possible to over-dry fabrics, if too long a time has been set. This can cause the fabrics to wrinkle, shrink or feel harsh. Synthetic materials can also become charged with static electricity.

Fabric Care Chart

	Resistant material		Can be ironed at 100°C max
	Delicate fabric		Do not iron
	Item may be washed at 95°C		Can be dry cleaned using any solvent
	Item may be washed at 60°C		Dry clean with perchloride, lighter fuel, pure alcohol or R113 only
	Item may be washed at 40°C		Dry clean with aviation fuel, pure alcohol or R113 only
	Item may be washed at 30°C		Do not dry clean
	Item may be hand washed		Dry flat
	Dry clean only		Can be hung to dry
	Can be bleached in cold water		Dry on clothes hanger
	Do not bleach		Tumble dry, normal heat
	Can be ironed at 200°C max		Tumble dry, reduced heat
	Can be ironed at 150°C max		Do not tumble dry

CARE AND MAINTENANCE



➤ **Cleaning the Exterior**

- Wipe the dryer surfaces, including the control panel, with a soft cloth and non-abrasive household detergents.
- Use a soft cloth to dry the surfaces.
- Do not pour water on the dryer.

➤ **Cleaning the Filters**

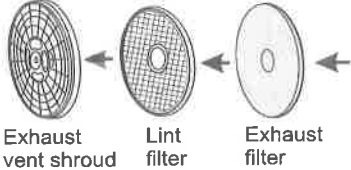
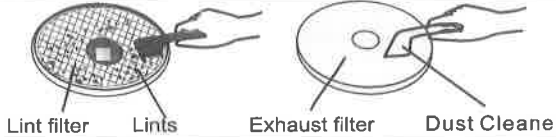
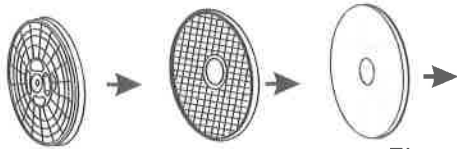
Unplug the power cord prior to any cleaning.

Cleaning the Lint Filter:		
a)	<p>Removing the Lint Filters: Remove by pulling outward using the four (4) grip holes in the filter assembly.</p>	<p>ALL FILTERS MUST BE IN PLACE WHEN DRYING</p> <p>FILTERS MUST BE CLEANED BEFORE AND AFTER EACH USE.</p>
b)	<p>The filter assembly consists of three (3) parts (See illustration)</p> <ol style="list-style-type: none"> a) Exhaust Vent Shroud b) Lint Filter c) Exhaust Filter 	 <p style="text-align: center;">Exhaust vent shroud Lint filter Exhaust filter</p>
c)	<p>Separate each of the above parts and clean the individual pieces using a SOFT brush or vacuum cleaner. DO NOT damage the filters</p>	 <p style="text-align: center;">Lint filter Lints Exhaust filter Dust Cleaned</p>
d)	<p>Re-install the filter assembly Reassemble the filter assembly in order Exhaust Filter - Lint Filter - Exhaust Shroud Align the entire assembly with the recessed position in the back of the drum and press firmly until the entire assembly is secure.</p>	 <p style="text-align: right;">Figure 3</p>

Cleaning the Air Intake Filter		
a)	<p>Removing the Air Intake Filter: Remove by pulling outward holding the filter housing by the top and bottom.</p>	
b)	<p>Remove the filter inside the housing and clean using a SOFT brush or vacuum cleaner.</p>	 <p style="text-align: center;">Air intake filter</p>
c)	<p>Replace the filter housing by pushing upwards with your thumb until the latch is secure.</p>	

PROBLEMS WITH YOUR DRYER?

You can solve many common appliance problems easily, saving you the cost of a possible service call. Try the suggestions below to see if you can solve the problem before calling the servicer.

TROUBLESHOOTING GUIDE

PROBLEM	POSSIBLE CAUSE
Timer knob will not rotate Dryer does not operate.	Not plugged in. The circuit breaker tripped or blown fuse. Door is not closed.
Drum does not rotate Laundry not completely dry	Clean the Filter Reduce the amount of clothing loaded in the dryer. Re-dry the loaded items Ensure items are not knotted or bulked together. Dryer is not located in a well ventilated area.

SERVICE FOR YOUR DRYER

We are proud of our customer service organization and the network of professional service technicians that provide service on your Avanti appliances. With the purchase of your Avanti dryer, you can have the confidence that if you ever need additional information or assistance, the Avanti Products Customer Service team will be here for you. Just call us toll-free.

AVANTI PRODUCTS CUSTOMER SERVICES

Product Information 800-323-5029	Whatever your questions are about our products, help is available.
Part Orders 800-220-5570	You may order parts and accessories that will be delivered directly to your home. You may order these items by personal check, money order, Master Card, or Visa.
In-Home Repair Service 800-220-5570	An Avanti Products authorized service center will provide expert repair service, scheduled at a time that is convenient for you. Our trained servicers know your dryer inside and out.

YOUR AVANTI PRODUCTS WARRANTY	Staple your sales receipt here. Proof of original purchase date is needed to obtain service under warranty.
<u>WHAT IS COVERED – LIMITED ONE-YEAR WARRANTY</u>	
<p>Avanti Products warrants that the product is free from defects in materials and/or workmanship for a period of twelve (12) months from the date of purchase by the original owner. The foregoing timeline begins to run upon the date of purchase, and shall not be stalled, tolled, extended, or suspended for any reason whatsoever unless described in detail in the warranty document. For one year from the date of purchase by the original owner, Avanti products will, at its option, repair or replace any part of the product which proves to be defective in material or workmanship under normal use. Avanti Products will provide you with a reasonably similar product that is either new or factory refurbished. During this period Avanti Products will provide all parts and labor necessary to correct such defects free of charge, so long as the product has been installed and operated in accordance with the written instructions in this manual. In rental or commercial use, the warranty period is 90 days. All Avanti appliances of 4.1 cubic feet capacity or less must be brought/sent to the appliance service center for repair.</p>	
<u>LIMITED FIVE YEAR WARRANTY ON PLASTIC TUB (CLOTHES WASHERS ONLY)</u>	
<p>After one year and until five years from the date of purchase, Avanti Products will furnish a replacement plastic tub, for one which is defective in material or workmanship. All labor and transportation charges are the responsibility of the consumer.</p>	
<u>LIMITED SEVEN YEAR WARRANTY ON STAINLESS STEEL TUB (Clothes Washer And Dryer)</u>	
<p>After one year and until seven years from the date of purchase, Avanti Products will furnish a replacement tub, for one which is defective in material or workmanship. All labor and transportation charges are the responsibility of the consumer.</p>	
<u>WARRANTY EXCLUSIONS / WHAT IS NOT COVERED:</u>	
<p>The warranty coverage described herein excludes all defects or damage that are not the direct fault of Avanti Products, including without limitation, one or more of the following:</p>	
<ul style="list-style-type: none"> • A failure to comply with any applicable state, local, city, or county electrical, plumbing and/or building codes, regulations, or laws, including failure to install the product in strict conformity with local fire and building codes and regulations. • Any external, elemental and/or environmental forces and factors, including without limitation, rain, wind, sand, floods, fires, mud slides, freezing temperatures, excessive moisture or extended exposure to humidity, lightning, power surges, structural failures surrounding the appliance, and acts of God. 	
<ul style="list-style-type: none"> • Incidental or consequential damages • Parts and labor costs for the following will not be considered as warranty: <ul style="list-style-type: none"> • Inner door panels, door shelves, door rails, and/or door supports. • Light bulbs and/or plastic housing. • Plastic cabinet liners. • Failure of the product if it is used for other than its intended purpose. • Shipping and handling costs associated with the replacement of the unit. 	<ul style="list-style-type: none"> • Repairs performed by unauthorized servicers. • Service calls that are related to external problems, such as abuse, misuse, inadequate electrical power, accidents, fire, floods, or any other acts of God. • Surcharges including but not limited to, any after hour, weekend, or holiday service calls, tolls, ferry trip charges, or mileage expense for service calls to remote areas. • The warranty does not apply outside the Continental USA.
<p>In no event shall Avanti Products have any liability or responsibility whatsoever for damage to surrounding property, including cabinetry, floors, ceilings, and other structures and/or objects around the product. Also excluded from this warranty are scratches, nicks, minor dents, and other cosmetic damages on external surfaces and exposed parts; Products on which the serial numbers have been altered, defaced or removed; service visits for customer education, or visits where there is nothing wrong with the product; correction of installation problems (you are solely responsible for any structure and setting for the product, including all electrical, plumbing and/or other connecting facilities, for proper foundation/flooring, and for any alterations including without limitation cabinetry, walls, floors, shelving etc., as well as the resetting of breakers or fuses.</p>	
<u>OUT OF WARRANTY PRODUCT</u>	
<p>Avanti Products is under no obligation, at law or otherwise, to provide you with any concessions, including repairs, pro-rates, or product replacement, once this warranty has expired.</p>	

Registration Information

Thank you for purchasing this fine Avanti product. Please fill out this card and return it within 100 days of purchase and receive these important benefits:

- **Protect your product:**
We will keep the model number and date of purchase of your new Avanti product on file to help you refer to this information in the event of an insurance claim such as fire or theft.
- **Promote better products:**
We value your input. Your responses will help us develop products designed to best meet your future needs.

------(detach here)-----
Avanti Registration Card

Name	Model #	Serial #
Address	Date Purchased	Store/Dealer Name
City	State	Zip
Area Code	Occupation	
Phone Number	<u>As Your Primary Residence, Do You:</u> <input type="checkbox"/> Own <input type="checkbox"/> Rent	

Did You Purchase An Additional Warranty:

Extended None

Reason For Choosing This Avanti Product:

Please indicate the most important factors that influenced your decision to purchase this product.

- Price
- Product Features
- Avanti Reputation
- Product Quality
- Salesperson Recommendation
- Friend/Relative Recommendation
- Warranty
- Other _____

Your Age:

under 18 18-25 26-30
 31-35 36-50 over 50

Marital Status:

Married Single

Is This Product Used In The:

Home Business

How Did You Learn About This Product:

Advertising Product Features
 In Store Demo Personal Demo
 Other _____

Comments _____

D110J2P-IS-12222017

PRINTED IN CHINA