



MEDIC-AID® HEAVY-DUTY PLASTIC TOILET SEAT

MODEL #

COLOR #

3L2155T

DESCRIPTION:

Open front less cover, elongated, heavy-duty, injection molded solid plastic toilet seat. Features two large 3" lift bumpers, check hinges with non-corrosive 300 Series stainless steel posts and pintles and STA-TITE® Commercial Fastening System™. Seat contains DuraGuard® Antimicrobial* Built-In Seat Protection™. This seat complies with IAPMO/ANSI Z124.5-2013 Plastic Toilet Seats as a class Commercial Heavy Duty.

* DuraGuard® Antimicrobial does not protect users against bacteria, viruses, or other disease organisms. Always clean and wash this product thoroughly before and after each use.

SPECIFICATIONS:

Size:	Elongated
Material:	Plastic
Style:	Open Front less Cover
Bumpers:	Two
Hinges:	Plastic with 300 Series Stainless Steel Posts and Pintles
Fastening System:	STA-TITE® Commercial Fastening System™

FEATURES:

STA-TITE® Commercial Fastening System™

DuraGuard® Antimicrobial Built-In Seat Protection™

3" Lift Hinges and Bumpers

Non-Corrosive 300 Series Stainless Steel Posts and Pintles

DIMENSIONS:

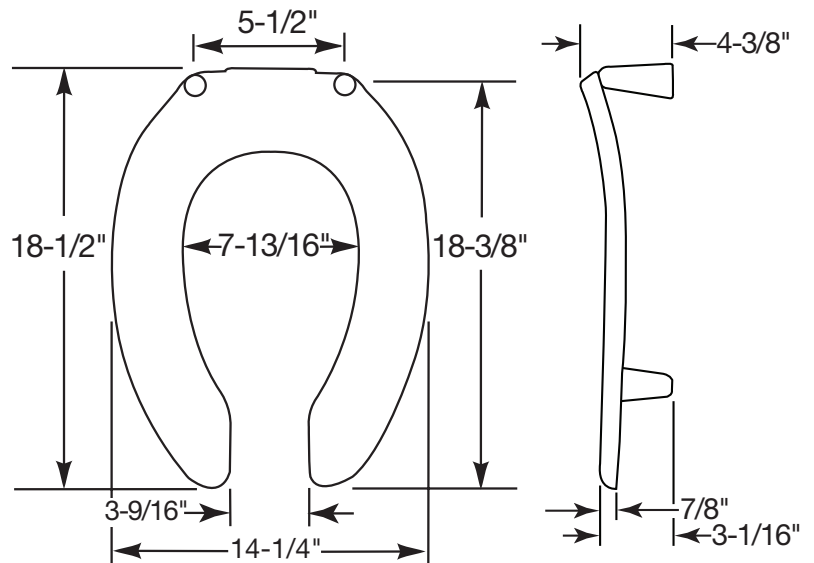

3" LIFT HINGES AND BUMPERS

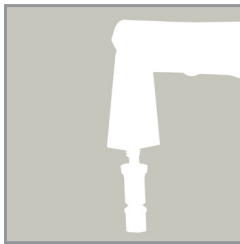

STA-TITE® COMMERCIAL FASTENING SYSTEM™

Proudly Made in the USA

Church Seats, Sheboygan Falls, WI 53085
www.ToiletSeats.com

Phone: 800-233-7328 Fax: 800-292-3647