

CRYST RAMA



1958

95 Cantiague Rock Road, Westbury NY 11590

ph:516.931.9090 fax: 516. 931.1254

info@crystorama.com www.crystorama.com

MODEL#:1135 ASSEMBLY AND DRESSING INSTRUCTIONS

A=  (9/50-2")*64PCS

B= 
(3 Jewels + 1 Square 4 Holes)+(3 Jewels + 9/75-3")*6PCS

C=  (14 Jewels Strand)* 12PCS

D=  (9/38-1.5")*6PCS

E=  (1 Ring + 1 Square 4 Holes + 9/75-3")*6PCS

F=  (1x 40mm Ball + 3 Jewels)*1PC

G= 
(24 Jewels Strand)*6PCS

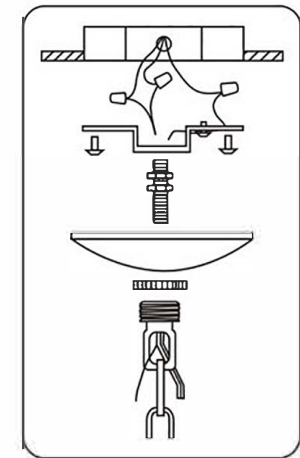

1 Bobeche with
4 **A** Trim.

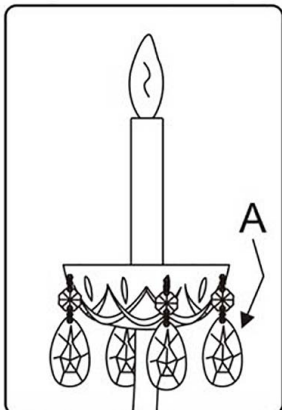

All electrical components must be installed by a licensed electrician in accordance with the National Electric Code and the appropriate local electrical codes.

