

CRYSTORAMA

95 Cantlague Rock Road, Westbury NY 11590.toll free:1.800.888.4470 fax:516.931.1254 Info@crystorama.com www.crystorama.com

MODEL#: 2107-AG ASSEMBLY AND DRESSING INSTRUCTIONS

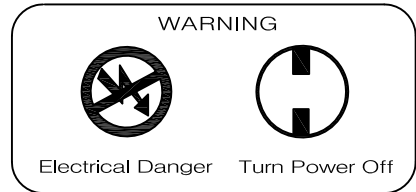

WARNING: This product can expose you to Lead, which is known to the State of California to cause cancer and/or birth defects or reproductive harm. For more information go to www.P65Warnings.ca.gov

IMPORTANT

TURN OFF THE POWER AT THE MAIN FUSE OR CIRCUIT BREAKER BOX BEFORE STARTING INSTALLATION

You will need 1-Medium. BULB 60 watts Max
Bulb not included
USE LED BULBS FOR EXTENDED USE

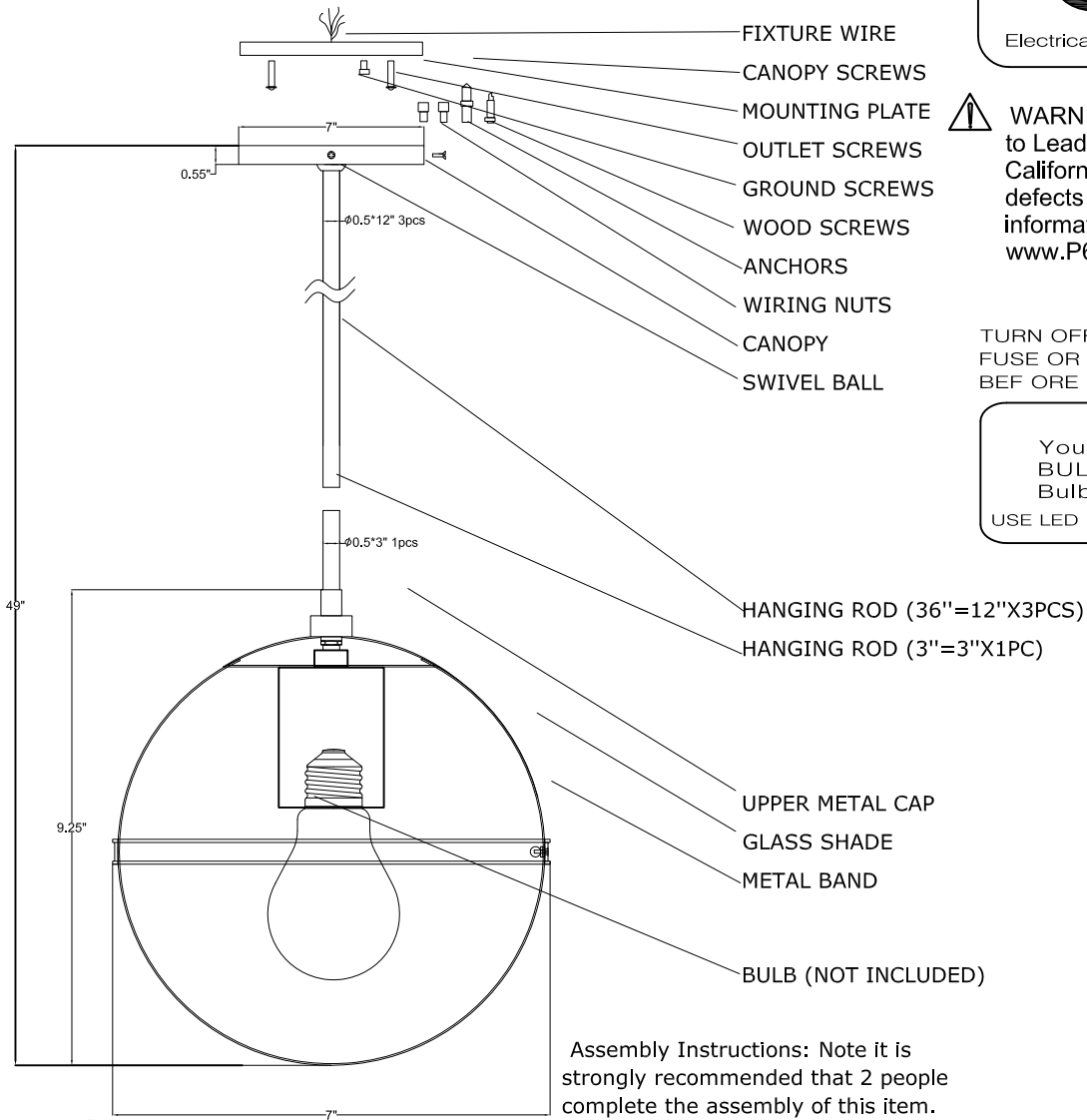

Assembly Instructions: Note it is strongly recommended that 2 people complete the assembly of this item.

1. Install the Metal Band onto the Glass Shade (rest the glass shade inside the foam block included in the packaging. Hold the metal band straight while another person secures it on the glass with the screws provided).
2. Unscrew the decorative nut.
3. Attached bulbs into the socket cluster.
4. Attached the lower metal cap and socket cluster into the glass shade
5. Attached the upper metal cap onto the glass shade and secure the decorative nut.

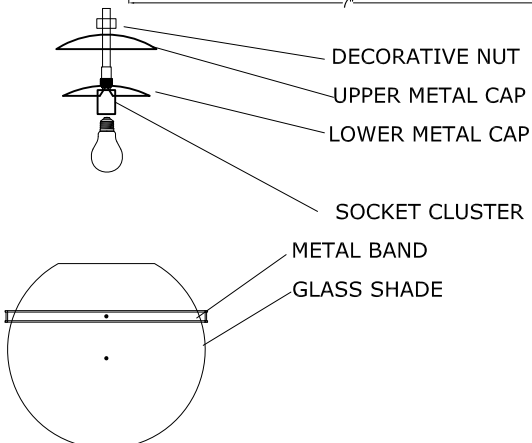
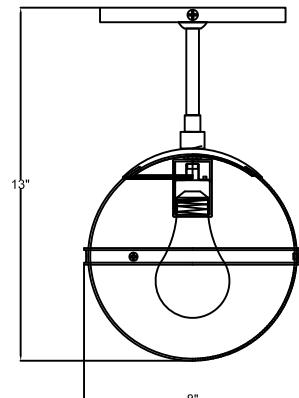

NOTICE: TO REPLACE THE BULB, PLEASE UNSCREW THE BOTTOM FINIAL FROM BOTTOM METAL CAP AS SHOWN ABOVE