

Model Number: 0105-K, 5105-K
072TM2, 572TM2

Tools:



Adjustable Wrench Phillips screwdriver Plumbers Putty Teflon Tape Rags

Warnings and Notes:

Check with local plumbing code requirements before installation.
This product should be installed by a local listed plumber.

Do not use plumbers putty on threads.



Installation Steps:

Single Handle Pull-Down Pre-Rinse Kitchen Faucet

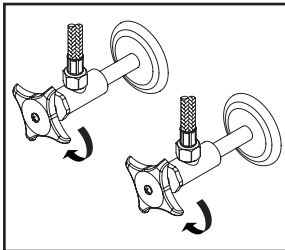

(1) Shut off water supplies. Remove old faucet. Clean mounting surface in preparation for new faucet.

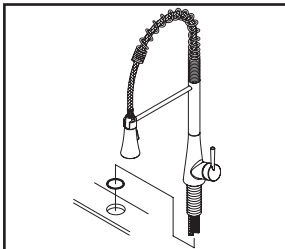

(2a) **For 1-Hole Installation:-** Ensure there is a washer under the faucet. Place the faucet in position on the sink.

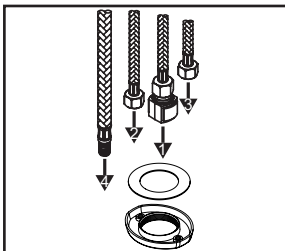

(2b) With flat side of the locknut facing down and the steel washer inside the locknut please follow the order as the drawing shows to insert flex hoses through the center hole of the locknut from underneath the sink.

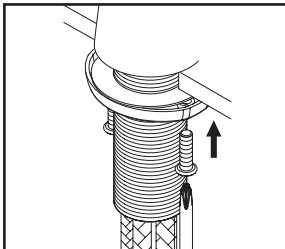

(2c) Thread locknut onto the faucet shank from underneath the sink. Position faucet to desired location from the top and hand-tighten locknut till it won't go further. Thread both screws on locknut and tighten screws on locknut with the help of a Phillips head screwdriver to secure faucet. (Note: Do not overtighten.)

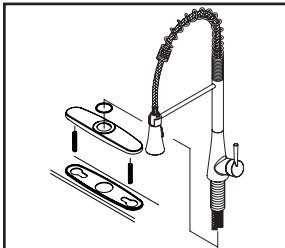

(3a) **For 3-Hole Installation:-** Place faucet on the deck plate, hand-tighten locknut to the faucet, tighten screws on locknut with the help of Phillips head screwdriver to secure the faucet. Thread mounting bolts to deck plate, apply plumbers putty under the base gasket and lead inlet & outlet flex hoses through center mounting hole to place faucet with base gasket in position on the sink.

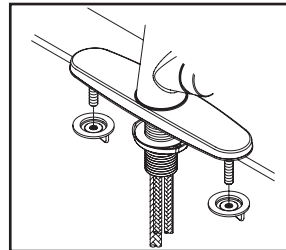

(3b) Thread and tighten both mounting nuts to mounting bolts from underneath of the sink to secure deck plate.

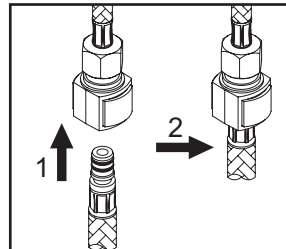

(4) Insert spray head hose into end of quick connect adapter on the outlet hose, push until a "click" is heard. Pull down to test engagement.

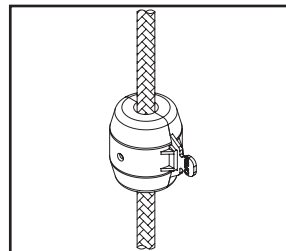

(5) Install weight on spray head hose. Adjust weight's position so the spray head can be retracted properly.

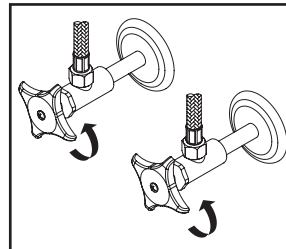

(6) Connect hot and cold inlet supply hoses to supply stops. For supply stop with 1/2" outlet connection, use 3/8" male to 1/2" female adapter for installation. Adapters are optional and are not provided with the faucet. Turn on both side supply stops to check any leaks.

Model Number: 0105-K, 5105-K

* Note: Please specify finish/color when ordering.

	ITEM #	DESCRIPTION
A1	OP-420082*	1.5 GPM Spray Head (For 0105-K)
A2	X-4200194*	1.5 GPM Spray Head (For 5105-K)
B	X-4200198*	Spray Hose
C	OP-420069*	Spring
D	X-4200191	Spout Repair Kit
E	OP-390003	Ceramic Disc Cartridge
F	OP-420057	Retainer Nut
G	OP-420058*	Cap
H	OP-120004*	Lever Handle
I	OP-420059	Washer
J	X-4200199	Quick Connect
K	OP-520015	Locknut with Screws
L	OP-420070	Weight
M	OP-420045*	Deck Plate & Base Gasket
N	OP-520003	Mounting Bolts & Nuts
1	OP-420061	Allen Screw
2	OP-420075	Washer

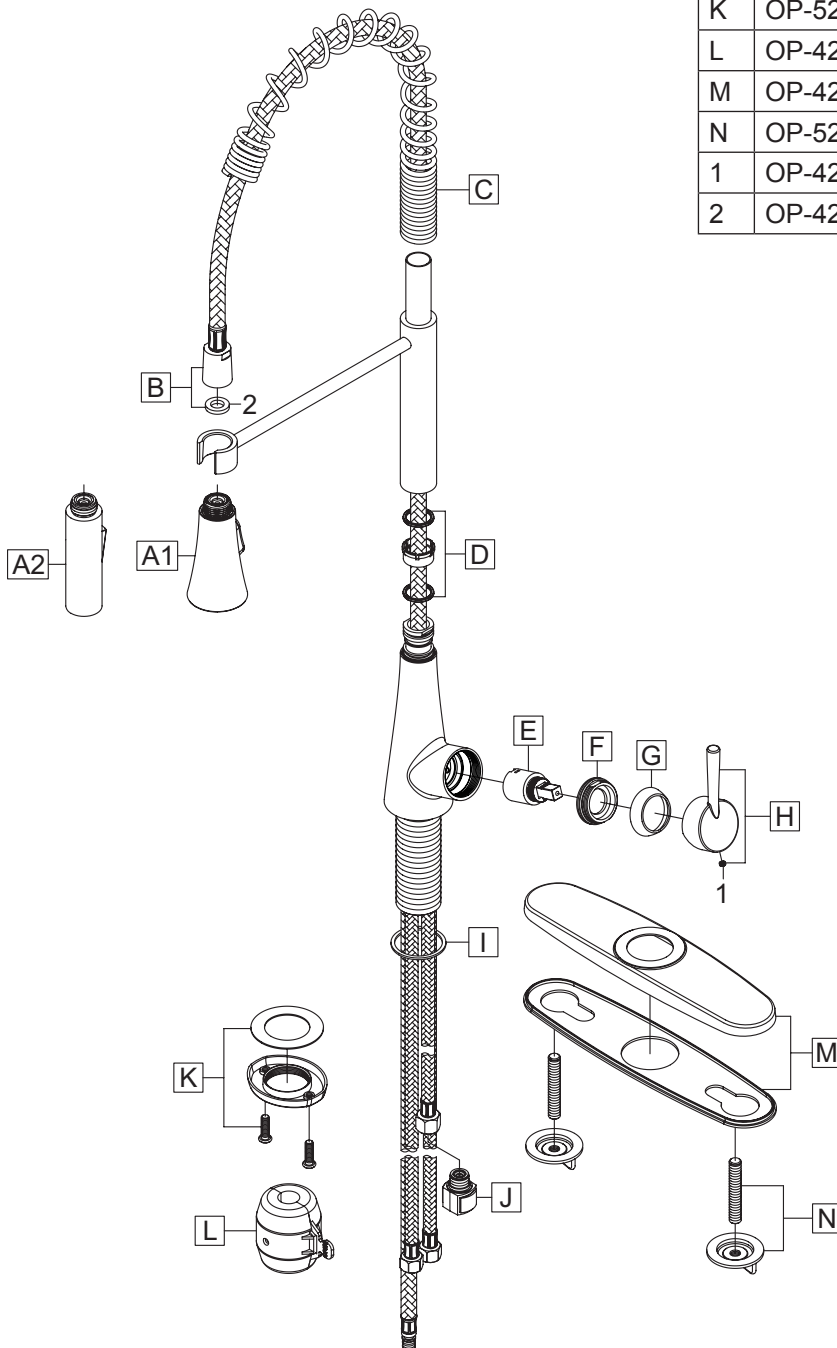

Model Number: 072TM2, 572TM2

* Note: Please specify finish/color when ordering.

	ITEM #	DESCRIPTION
A	X-4200194*	1.5 GPM Spray Head
B	X-4200198*	Spray Hose
C	X-4200188*	Spring
D	X-4200191	Spout Repair Kit
E	X-3900008	Ceramic Disc Cartridge
F	X-4200192	Retainer Nut
G	X-4400032*	Cap
H	X-1200024*	Lever Handle
I	X-4200187	Gasket
J	X-4200199	Quick Connect
K	OP-520015	Locknut with Screws
L	OP-420070	Weight
1	X-4400024	Allen Screw
2	X-4900044*	Hole Cover
3	OP-420075	Washer

