

Model Number: 061TM3-WD, 071TM3-WD
871TM3, 081TM3

Tools:



Adjustable Wrench Plumbers Putty Teflon Tape Rags

Warnings and Notes:

Check with local plumbing code requirements before installation.
This product should be installed by a local listed plumber.

Do not use plumbers putty on threads.



Installation Steps:

Single Handle Lavatory Faucet

Pop-up Drain Installation:

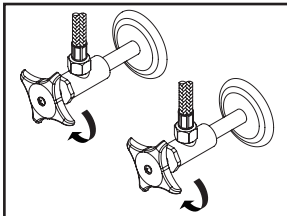

(1) Shut off water supplies. Remove old faucet. Clean mounting surface in preparation for new faucet.

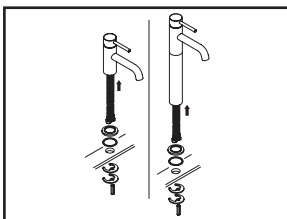

(2a) For 1-Hole Installation:- Install mounting bolt to the bottom of the faucet. Place 8" extension and align it for model # 871TM3. Place escutcheon with gasket under the faucet then place the faucet in position on the sink. Slide mounting washer and mounting plate through mounting bolt from underneath the sink, tighten locknut to mounting bolt.

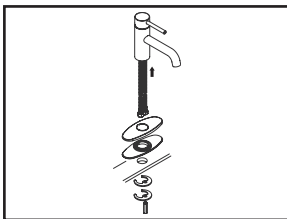

(2b) For 3-Hole Installation:- Install mounting bolt to the bottom of the faucet. Place deck plate with gasket under the faucet then place faucet in position on the sink. Slide mounting washer and mounting plate through mounting bolt from underneath the sink, tighten locknut to mounting bolt.

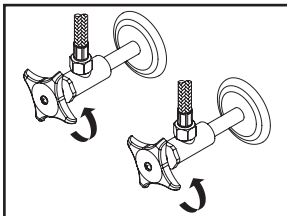

(3) Connect hot and cold inlet supply hoses to supply stops. For supply stop with 1/2" outlet connection, use 3/8" male to 1/2" female adapter for installation. Adapters are optional and are not provided with the faucet. Turn on both side supply stops to check any leaks.

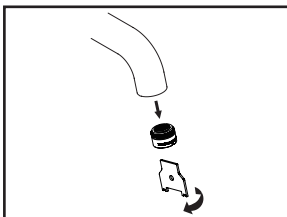

(4) Important: After installation is complete, remove the aerator. Turn on the water and allow both hot and cold water to run for at least one minute each. While water is running, check for leaks. Turn off the water and replace the aerator when finished.

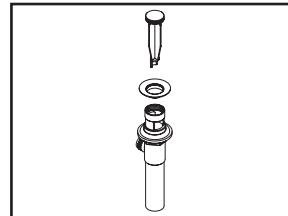

(1) Remove pop-up flange from body

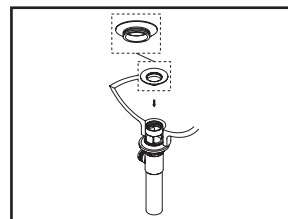

(2) Place a ring of plumbers putty on the bottom of flange.

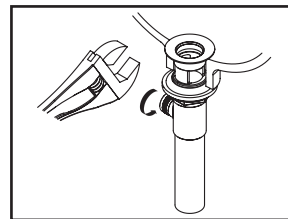

(3) Insert pop-up flange through drain hole and attach flange to the pop-up drain body. Apply Teflon tape on the threaded end of the tail piece and attach tail piece to the pop-up drain body. Ensure the pivot rod hole of the pop-up drain body faces towards the back of the sink. Tighten the locknut with the help of a wrench to secure the pop-up drain body.

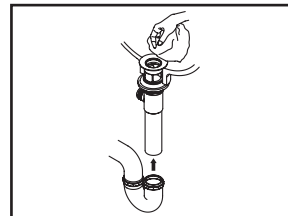

(4) Remove the excess plumbers putty. Connect the trap (check manufacturer's instructions for installation).

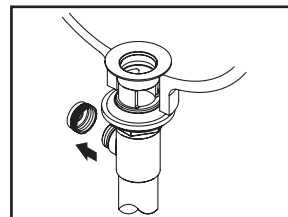

(5) Remove pivot rod nut from pop-up body, ensure the washers is in place, insert pivot rod, tighten pivot rod nut back to pop-up body.

Model Number: 061TM3-WD, 071TM3-WD
871TM3, 081TM3

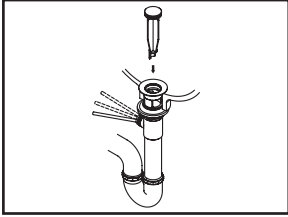

(6) Push pivot rod down, insert drain plug carefully. Test to ensure drain plug works properly.

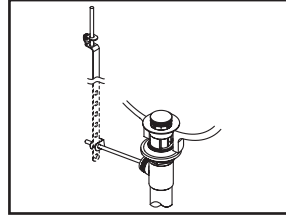

(7) Connect lift rod strap to pivot rod by using clip. Tighten the thumbscrew to connect lift rod strap to pop-up lift rod.

EXPLODED DRAWING

Model Number: 061TM3-WD, 071TM3-WD

* Note: Please specify finish/color when ordering.

	ITEM #	DESCRIPTION
A	X-1900008*	Motegi Lever Handle
B	X-4900017*	Cap
C	X-4900018	Retainer Nut
D	X-3900001	Ceramic Disc Cartridge
E	OP-490062	1.2 GPM Aerator & Tool
F	X-4300019*	Escutcheon and Gasket
G	X-5300012	Mounting Kit
H	X-6300006*	Brass Pop-Up Drain Assembly
I	OP-430026*	Deck Plate
1	X-4900044*	Hole Cover
2	X-4400024	Allen Screw

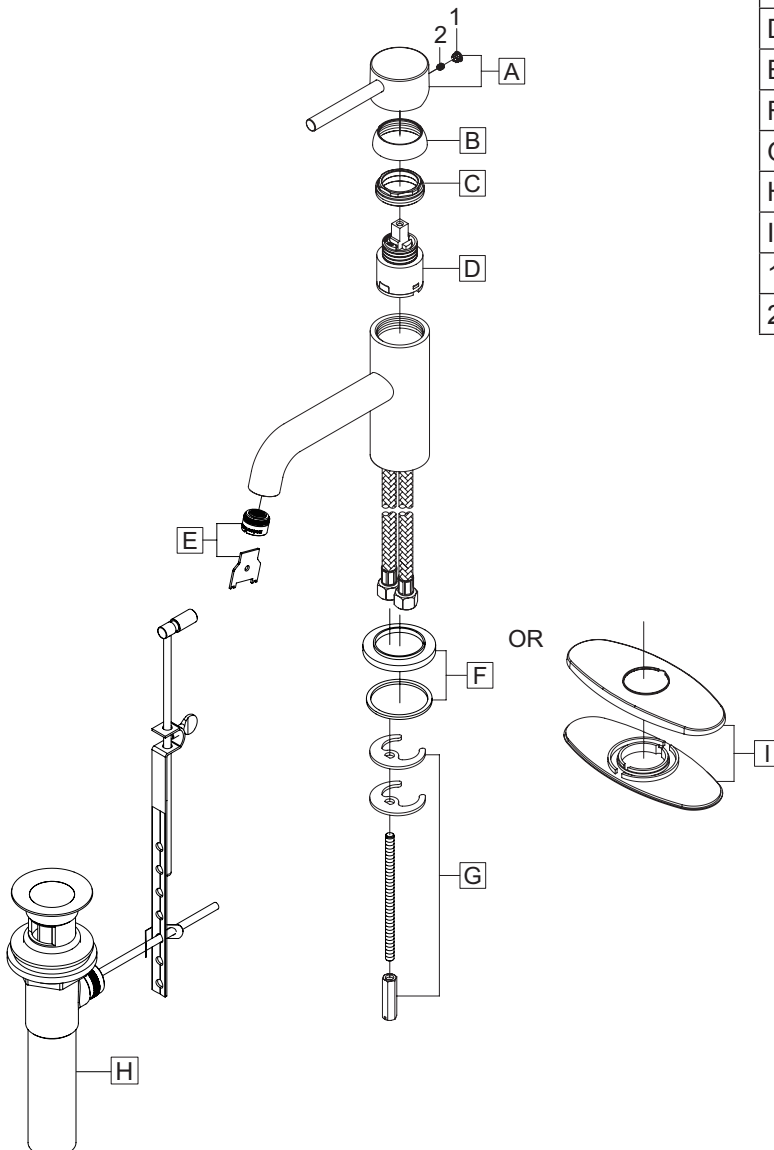

Model Number: 871TM3

* Note: Please specify finish/color when ordering.

	ITEM #	DESCRIPTION
A	X-1900008*	Motegi Lever Handle
B	X-4900017*	Cap
C	X-4900018	Retainer Nut
D	X-3900001	Ceramic Disc Cartridge
E	OP-490062	1.2 GPM Aerator & Tool
F	X-4300022*	8" Extension
G	X-4300019*	Escutcheon and Gasket
H	X-5300008	Mounting Kit
1	X-4900044*	Hole Cover
2	X-4400024	Allen Screw

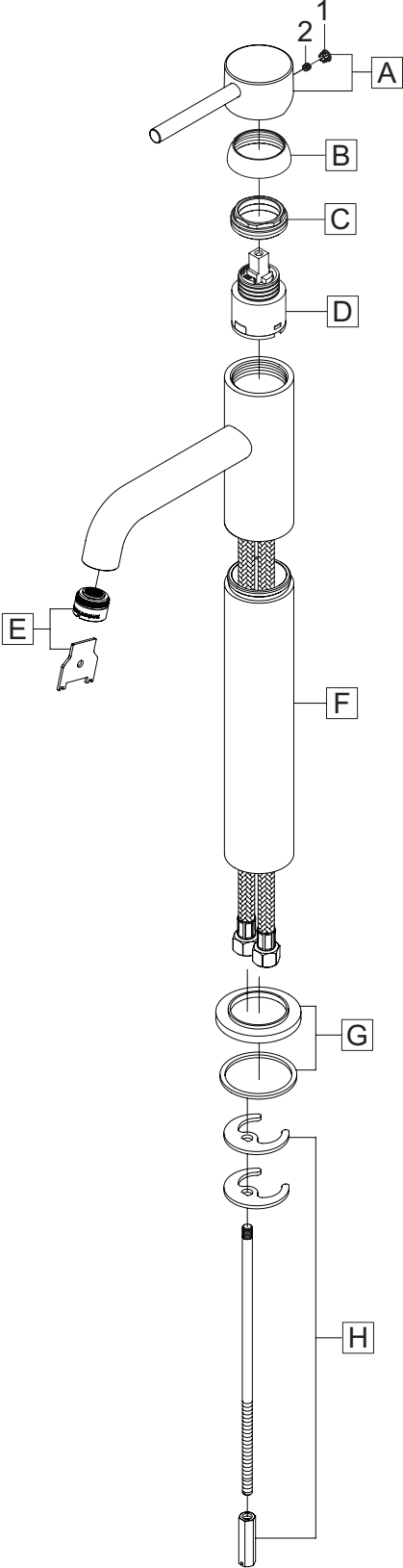

Model Number: 081TM3

* Note: Please specify finish/color when ordering.

	ITEM #	DESCRIPTION
A	X-2300024*	Motegi Series Spout
B	X-3900003	Ceramic Disc Cartridge
C	X-4900018	Retainer Nut
D	X-4900017*	Cap
E	X-1900008*	Motegi Lever Handle
F	X-4300019*	Escutcheon and Gasket
G	X-5900002	Mounting Kit
H	X-6300006*	Brass Pop-Up Drain Assembly
1	OP-490062	1.2 GPM Aerator & Tool
2	X-4900070	Spout O-rings
3	X-4900044*	Hole Cover
4	X-4400024	Allen Screw

