

INSTALLATION INSTRUCTIONS



Wyatt® Console Lavatory Kit Model D21460

Thank you for selecting DXV. To ensure this product is installed properly, please read these instructions carefully before you begin. (Certain installations may require professional help.) Also be sure your installation conforms to local codes.

▲ CAUTION: PRODUCT IS FRAGILE. TO AVOID BREAKAGE AND POSSIBLE INJURY HANDLE WITH CARE!
NOTE: Pictures may not exactly define contour of china and components.

RECOMMENDED TOOLS AND MATERIALS

Most of the procedures require the use of common tools and materials, which are available from hardware and plumbing supply stores. It is essential that the tools and materials be on hand before work is begun.

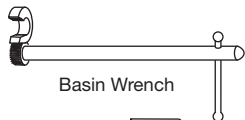

Basin Wrench



Regular Screwdriver

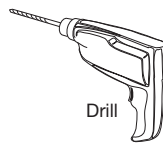

Drill



Level



Tape Measure

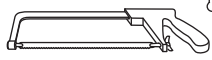

Hacksaw

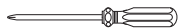

Phillips Screwdriver



Plumbers' Putty or
Caulking



Saber Saw



Pipe Wrench



Adjustable Wrench



Channel Lock



Putty Knife

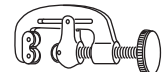

Tubing Cutter

ROUGHING-IN DIMENSIONS:

- For reference

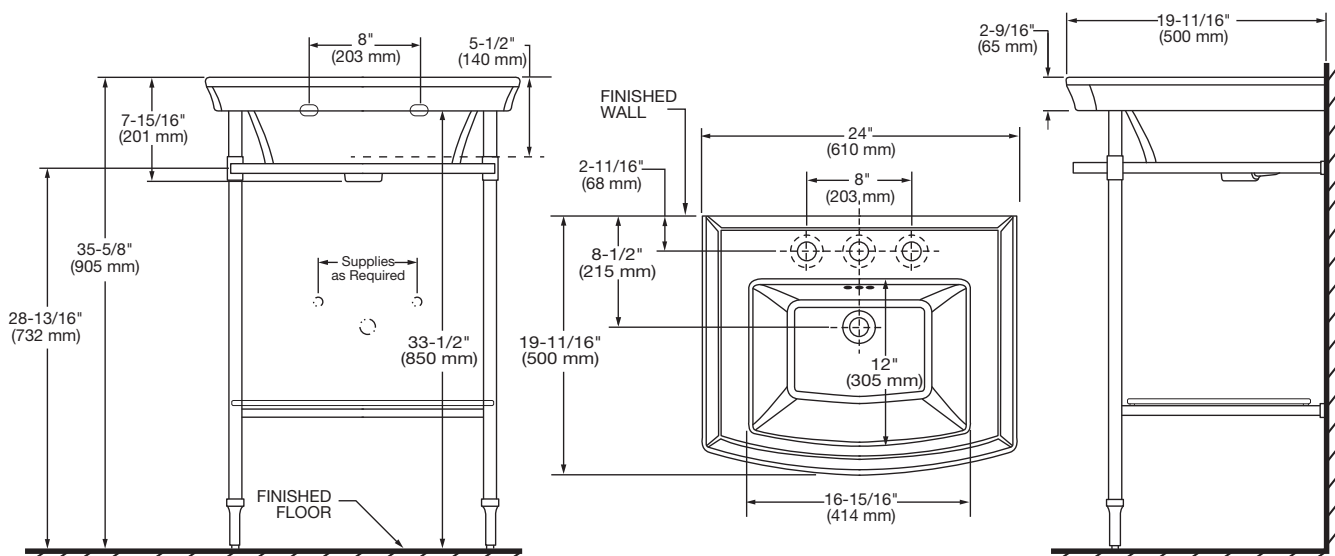

NOTE: Locate supplies and "P" trap in open area.

SAVE FOR FUTURE USE

EXPLODED VIEW

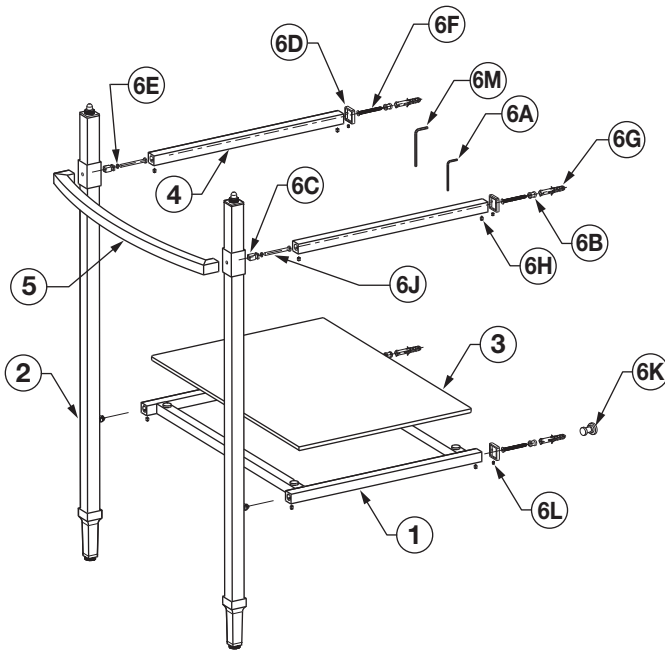

ITEM	DESCRIPTION	PART NUMBER
1	(1) Glass Shelf Frame	770209-201.YYY0A
2	(1) Leg	770210-201.YYY0A
3	(1) Glass Shelf	770211-201.YYY0A
4	(1) Support Tube - Horizontal	770212-201.YYY0A
5	(1) Towel Bar	770213-201.YYY0A
6	HARDWARE/COMPONENT KIT 6A - (1) Allen Wrench - M5 6B - (4) Circular Connectors 6C - (2) Square Connectors 6D - (4) Wall Escutcheons 6E - (2) Lock Washers - 304 Stainless Steel 6F - (4) Wood Screws - M5x50mm - Countersunk Head 6G - (4) Wall Anchors 6H - (8) Set Screws - M5x5mm 6J - (2) Screws - M5x50mm - Mushroom Head 6K - (4) Locator Pins 6L - (4) Set Screws - M3x3.5mm (Factory Installed) 6M - (1) Allen Wrench - M3 6N - (1) Bumper Replacement Kit (not shown)	770214-201.YYY0A

1 CONSOLE STAND INSTALLATION

IMPORTANT: Suitable reinforcement is required for anchoring the lavatory to the wall.

Determine horizontal centerline location “★” of lavatory mounting holes. (see Figure 1).

Rough in supply lines and waste per rough in dimensions.

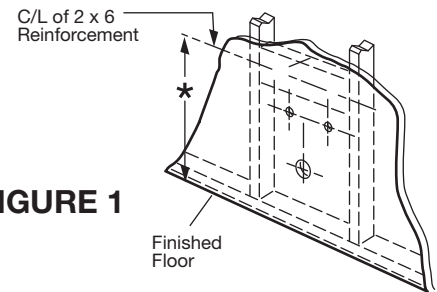

FIGURE 1

2 Insert the Locator Pins (6K) into the round holes in the ends of Glass Shelf Frame (1) so that the points face out. The shoulders must be flush with the end of the Glass Shelf Frame. (see Figure 2)

Install the M5x5 mm Set-Screws (6H) into the Glass Shelf Frame. Tighten the Set Screws so that the Locator Pins are secure.

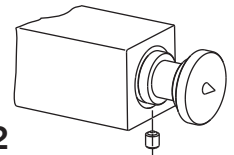

FIGURE 2

3 Attach the other ends of the Glass Shelf Frame to the Legs (2), by sliding the ends with the notched round holes (Figure 3) over the factory-installed Square Connectors (6C).

NOTE: The Set-Screw holes are located on the underside of Glass Shelf Frame.

Install the Set-Screws and, with the ends of the Glass Shelf Frame flush with the side of the Legs, tighten the Set-Screws securely.

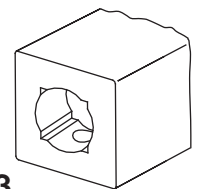

FIGURE 3

4 Insert a Square Connector into the recess in the Leg, with the notched end outward. Slide a Lock Washer (6E) onto a M5x50mm Mushroom Head Screw (6J) and insert it into the hole in the center of the Square Connector (6C), threading it into the Towel Bar (5).

NOTE: Do not tighten completely at this time.

5 Repeat Step 4 with the other Leg and tighten both screws from Steps 4 & 5 securely.

6 Insert the Locator Pins into the round holes in the end of the Horizontal Support Tubes (4) so that the points face out and the shoulder is flush with the Horizontal Support Tube. (see Figure 4)

Install the Set Screws into the threaded holes in the Horizontal Support Tube and tighten so that the Locator Pins are secure.

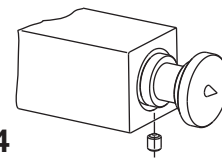

FIGURE 4

7 Attach the opposite ends of the Horizontal Support Tubes to the Legs by sliding the ends with the notched round holes over the Square Connectors. (see Figure 5)

NOTE: The Set-Screw holes are located on the underside of the Horizontal Support Tubes.

Install the Set Screws and, with the ends of the Horizontal Support Tube flush with the side of the Legs, tighten the Set Screws securely.

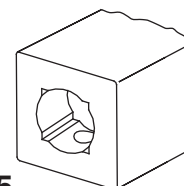

FIGURE 5

8 Place a 25" strip of Painter's Tape on the wall, centered at a height of 10-1/4" (260 mm) above the finished floor.

Add a second piece of tape on the wall, centered at a height of 28-7/8" (733 mm) above the finished floor.

9 Beginning with the foot leveling adjusters fully tightened, rotate the adjusters counter-clockwise 2 full turns.

With the Horizontal Support Tubes and Glass Shelf Frame level in both directions (Figure 6), slide the Console Stand assembly into position against the wall so that the Locator Pins make an indentation on the Painter's Tape.

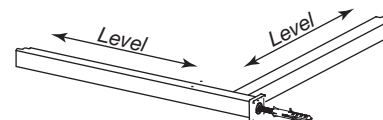

FIGURE 6

NOTE: Depending upon the degree to which your floor is level, the indentations should be within 1/8" of the dimensions shown on the rough-in illustration on page 1. It is recommended that you verify the dimensions before proceeding to Step 10.

10 Remove the Console Stand assembly. Using the indentations on the tape as location guides, pre-drill holes for the M5x50 mm Countersunk Head Wood Screws (6F) and/or Wall Anchors (6G). Use a 1/8" diameter drill bit for the Wood Screws and use a 3/16" diameter bit for the Wall Anchors.

NOTE: Use appropriate drill bit for the wall material.

Remove the remaining tape and attach the Circular Connectors (6B) to the walls using the Wood Screws and Wall Anchors (as required).

NOTE: The Wall Anchors are not required if the Wood Screws will be installed into studs and/or suitable cross-braces.

- 11** Slide the Escutcheons (6D) onto the Glass Shelf Frame (1) with the Set Screw holes on the same side as the Set Screw holes in the Glass Shelf Frame. (see Figure 7)
- Slide the Escutcheons onto the Horizontal Support Tubes (4) with the Set Screws on the same side as the Set Screw holes in the Horizontal Support Tubes.

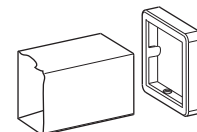

FIGURE 7

- 12** Loosen the Set Screws holding the Locator Pins in place, and remove the Locator Pins.

- 13** Slide the Console Stand assembly in to place and secure it to the Circular Connectors by tightening the Set Screws that were loosened in Step 12.
- Slide the Escutcheons against the wall and tighten the Set Screws.

- 14** Install the lavatory to the wall per the instructions provided. Ensure that the lavatory is securely fastened to the wall.
- NOTE: The lavatory must be fully supported by the wall.**
- Adjust the rubber bumpers on the top of the Legs until they just make contact with the lavatory.

- 15** Install the faucet and the drain per the manufacturer's instructions.

- 16** After the installing the faucet and drain, and the supply lines have been connected and checked for leaks, place the Glass Shelf (3) onto the Glass Shelf Frame.
- If the shelf does not sit on all of the rubber pads, replace the pads that do not make contact with the shelf with the thicker pads included in the Bumper Replacement Kit (6N). Replace the rear pad(s) first, then the front pad(s) as necessary.

In the United States:

DXV
One Centennial Avenue
Piscataway, New Jersey 08855
Attention: Director of Customer Care

For residents of the United States, warranty information may also be obtained by calling the following toll free number: (800) 227-2734
www.DXV.com

In Canada:

DXV
5900 Avebury Road
Mississauga, Ontario
L5R 3M3
Canada

Toll Free: 1-800-387-0369
Local: 905-306-1093
Fax: 1-800-395-1498

In Mexico:

DXV
Via Morelos 330
Col. Santa Clara Coatitla
Ecatepec, Estado de México 55540

Toll Free: 01-800-8391200
www.DXV.mx