

ELICA PRO SERIES TRENTO



ELICA'S EXCLUSIVE PLUS FEATURES



HUSH SYSTEM



LED REPLACEABLE



SEAMLESS LOOK



GREASE COLLECTORS



PERFORMANCE



HEAT GUARD

Trento provides professional grade performance, while being discreetly mounted inside the cabinetry. It is available with a 1200 CFM blower for extraordinary ventilating power. Plus the All-In-One design avoids the need to purchase a stainless liner. Hidden metallic in/out knob controls operate the 4-speed blower and LED lighting. A cleaner kitchen is ensured by Elica's patented angled baffle filters, which capture a higher percentage of contaminants and hold larger volumes of grease than traditional baffle filters.

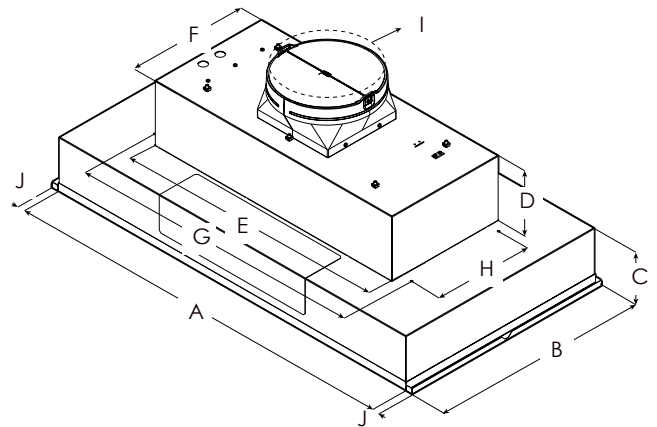

	ETR134S1
A	34 1/2" (87.6 cm)
B	18" (45.7 cm)
C	5 7/16" (13.8 cm)
D	6 1/2" (16.4 cm)
E	27 9/16" (70 cm)
F	12 7/16" (31.6 cm)
G	29 13/16" (75.7 cm)
H	10 1/8" (25.7 cm)
I	10" (25.4 cm)
J	3/4" (1.9 cm)

*Hood can be 34" or 36" with included spacers (A+J+J)



$\geq 24"$

$\geq 30"$

MOUNTING
HEIGHT
RANGE

ELICA PRO SERIES TRENTO





SPECIFICATIONS

	34" or 36" with spacers
Model:	ETR134S1
Dimensions:	34 1/2"W x 18"D x 11 1/2"H
Blower Type(internal):	1200 CFM (4-speed)
Blower Performance:	
Speed 1	380 CFM
Speed 2	660 CFM
Speed 3	950 CFM
Speed 4	1200 CFM
Noise (sones):	Min:2.05, Max:7.5
Working Speed	
Finish:	Stainless Steel
Controls:	Fully retractable rotating knobs with blue backlighting
Illumination:	2 LED, 7.5 W
(replaceable lamps 1 intensity)	
Filter Type:	Dishwasher-Safe, Professional Stainless Steel
Angled Baffle Filters:	2
Duct Transition:	10" Round with BackDraft Damper (top only)
Installation Type:	Ducted Installation Only
Electrical:	120V - 60 Hz
CONSUMABLE PARTS:	
Replacement Grease Filter (1):	GRI0140692A
Replacement Light Bulb (1):	LMP0131098

*Consumable parts are sold in units of one (1). Order accordingly

PLUS FEATURES

- 

HUSH SYSTEM - An exclusive sound deadening technology that effectively reduces sound levels by over 35%
- 

STAINLESS STEEL BAFFLE FILTERS WITH GREASE COLLECTORS - Designed for high airflow cooking, the "S" shape design traps high volumes of grease
- 

LED CONSUMER REPLACEABLE BULB - High quality LED lighting usually requires a skilled technician to replace lamps. Avoid this expense with Elica's new LED lamps that enable homeowners to replace in seconds
- 

PROFESSIONAL PERFORMANCE - Special features and high performances for models with aspiration capacity between 600 and 1200 CFM's
- 

SEAMLESS CRAFTSMANSHIP - Heavy gauge stainless steel "Seamless" construction that delivers refined elegance.
- 

HEAT GUARD - Senses extreme temperatures (>158 degrees) and automatically adjusts the blower speed to HIGH