

1 TO REMOVE HANDLE

BE SURE WATER SUPPLY IS TURNED OFF

 REMOVE PLUG BUTTON (if applicable)

Use Phillips screwdriver to remove handle screw.

Pull off handle from cartridge stem.

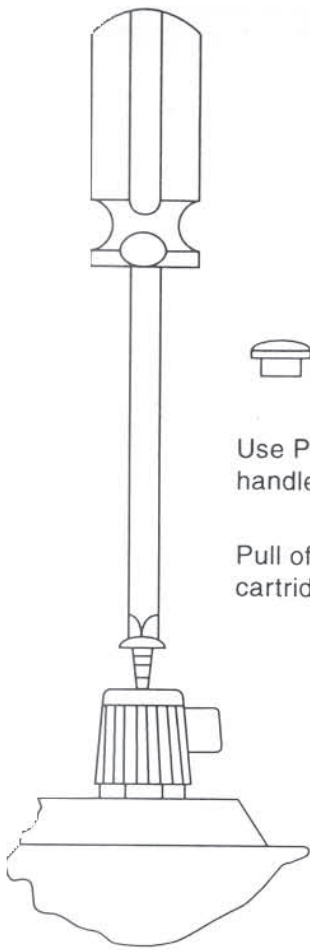

MAINTENANCE INSTRUCTIONS FOR ELKAY DIACORE CARTRIDGE EQUIPPED FAUCETS

Diacore Cartridge (Gray or Blue Stem) -- Handle Turns Clockwise to Open

Diacore Cartridge (Brown or Red Stem) -- Handle Turns Counterclockwise to Open

2 TO REMOVE CARTRIDGE NUT CAP

Use pliers to loosen cap, turn counterclockwise.

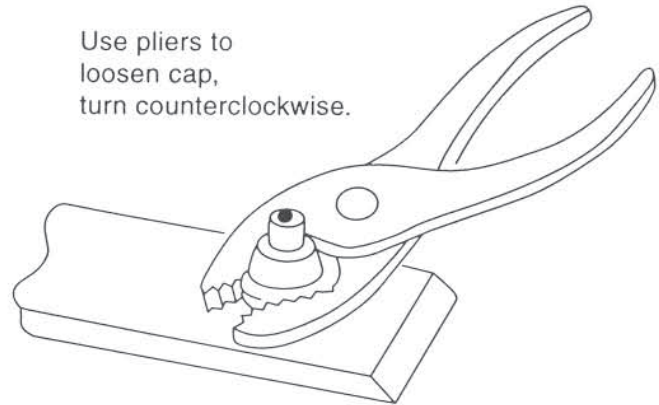

3 TO REMOVE CARTRIDGE

Screw handle screw into cartridge stem.

Grip screw and remove cartridge by pulling it straight out of socket.

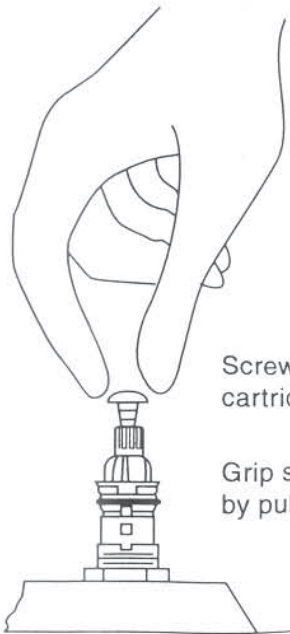

4 TO REPLACE CARTRIDGE

Reassemble all components in reverse order.

Grease "O" rings*

Do not nick or scratch rubber "O" rings when inserting new cartridge.

Be sure tabs on cartridge fit into faucet body slots.

NOTE: Cartridge flange must fit tight against faucet body shoulder.

Use pliers to tighten cap (2) securely.

TURN ON water supply.

 Plug Button (if applicable)

 Handle Screw

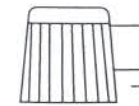
 Handle

 Cap

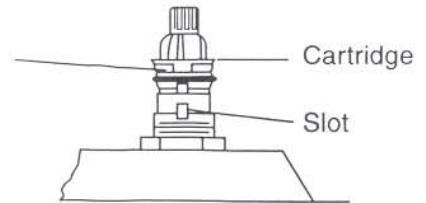
 Cartridge Slot

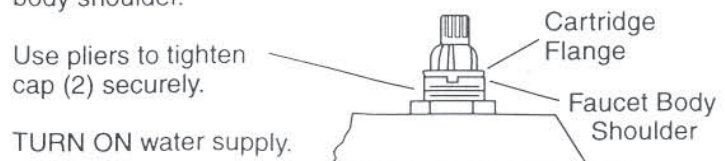
 Cartridge Flange Faucet Body Shoulder

*If "O" rings are not greased as received, use silicone lubricant provided.

LKBHD KIT INSTRUCTIONS
WARNING—THIS KIT CAN ONLY BE USED
ON MODELS LISTED BELOW.

Metal Diacore Cartridge (Blue Stem) --
 Handle Turns Clockwise to Open

Metal Diacore Cartridge (Red Stem) --
 Handle Turns Counterclockwise to Open

1 TO REMOVE
HANDLE

BE SURE
 WATER SUPPLY
 IS TURNED OFF

Use Phillips screwdriver to remove
 handle screw.

Pull off handle from
 cartridge stem.

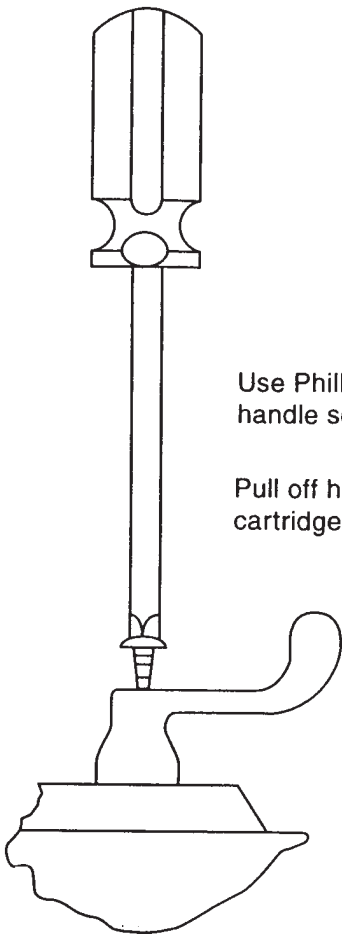

2 TO REMOVE
CARTRIDGE NUT CAP

Use pliers to
 loosen brass cap,
 turn counterclockwise.

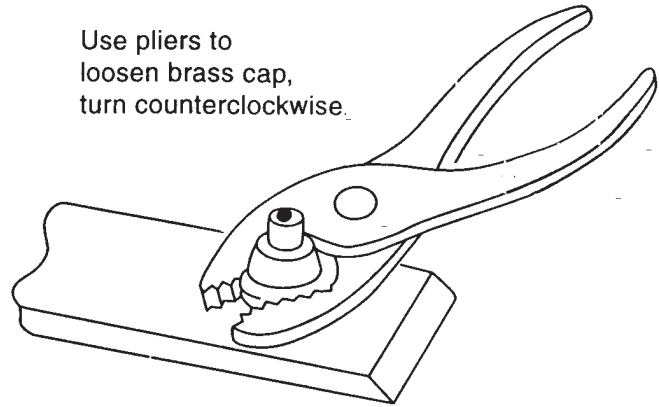

3 TO REMOVE
CARTRIDGE

Screw handle screw into
 cartridge stem.

Grip screw and remove cartridge
 by pulling it straight out of socket.

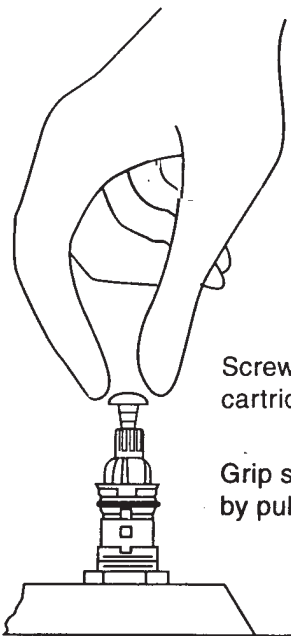

4 TO REPLACE
CARTRIDGE

Reassemble all components
 in reverse order.

Grease "O" rings*

Do not nick or scratch
 rubber "O" rings when
 inserting new cartridge.

Be sure tabs
 on cartridge fit into
 faucet body slots.

NOTE:
 Cartridge flange must
 fit tight against faucet
 body shoulder.

Use pliers to tighten
 cap (2) securely.

TURN ON water supply.

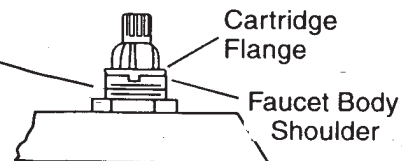
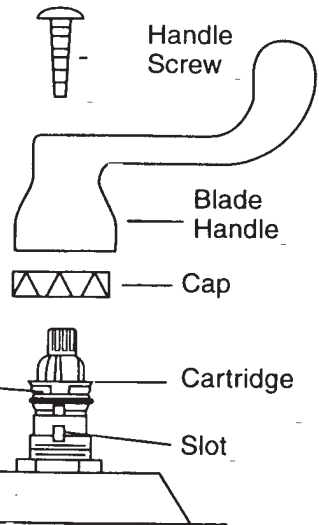

Models LKBHD KIT can be used on

LKC-2432	LKA-2438	LKA-2440	LK-2472	LKA-2448	LKA-2480
LK-2432	LK-2439	LKA-2446	LKA-2445	LKA-2479-8	LK-2490
LKA-2437	LK-2452	LK-2442	LKA-2447	LK-2489-8	

*If "O" rings are not greased as received, use
 silicone lubricant provided.