









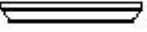
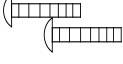

PARTS & ASSEMBLY SHEET

Fixture Name: Waverly 3500-SF AB

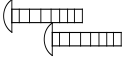
This fixture assembled PO: _____ Date: _____

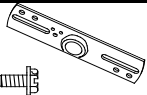
Notice: Please review the parts listing and check for all parts before assembling the fixture. If any parts are missing or damaged, please note on this sheet and contact the place of purchase to arrange for replacement parts.

PARTS LIST		Company Name: _____ Co. Account #: _____ to be filled out by retailer	
Mounting strap (circular) 1ea D4"		Wire connectors 3ea P3 Orange	 Deco nut 2ea 12mm
Canopy 1ea D6"x1"		Junction box screw 2ea 8/32" x 1"	 Top loop 1ea D50 x 60mm
Chain 1ea 6ft x3.8mm		Mounting screw 2ea 8/32" x 1-1/4"	 Canopy loop with Collar 1ea @3/8 x 40mm x 5mm
Chain connector 2ea @3X38mm		Hex nut 2ea @3/8 x 3mm	 Nipple 1ea @3/8 x 65mm
Mounting strap w/ ground screw 1ea 3/4"x4"		Screw 2ea @8/32" x 8mm	
Part Needed _____		Quantity _____	
Part Needed _____		Quantity _____	
Reason why _____	(missing, scratched, broken glass, bent, bad finish)		
Comments _____			

FIXTURE ASSEMBLY INSTRUCTIONS
Read and review installation instruction sheet before assembling the fixture.

- Place shade (Q) Thread the threaded pipe/stem (P) into the coupling at center of fixture body (R).
- Thread the top loop (J) onto the stem (P1)and(P). Hand-tighten until the Top Loop is snug.
- Install the light bulbs in accordance with the fixture's specifications.

(DO NOT EXCEED MAXIMUM WATTAGE RATING)

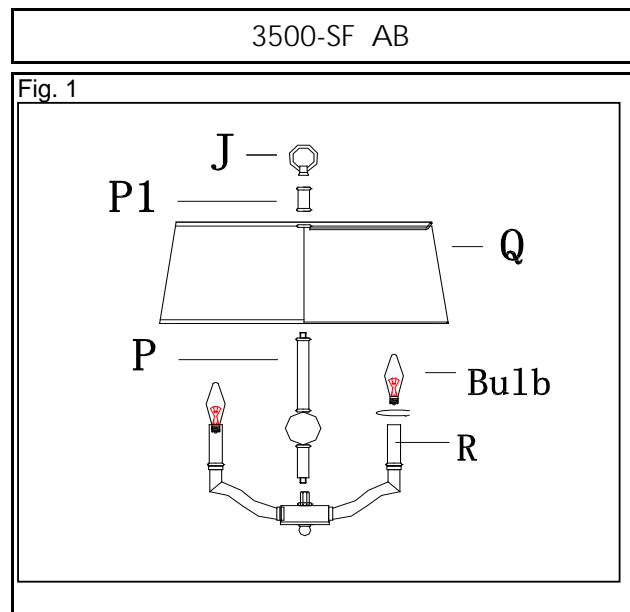

For Customer Service, contact the place of purchase to arrange for replacement parts.

PARTS & ASSEMBLY SHEET

Fixture Name: Waverly 3500-SF AB

ASSEMBLING THE FIXTURE as Chain hung (Fig.2)

1. Place Shade (Q) onto the threads of Threaded Stem (P) into the coupling at center of Fixture Body (R).

2. Thread the Top Loop (J) onto the Threaded Stem (P1) and (P). Hand-tighten until the Top Loop is snug.

3. Measure to determine the correct number of links needed for proper hanging height. Use a pair of pliers to open one link of Chain (K). Then remove and discard the excess chain.

4. Use Chain Connector (L) to attach one end of the chain to Top Loop (J) and close the chain connector.

5. Feed the fixture wires through the chain (every three links) and pull the wires until taut.

6. Slip Canopy Loop Collar (H) over the chain, then do the same with the Canopy (G).

9. To complete the installation, use the other chain connector to attach the other end of the chain to the Canopy Loop (F) and close the chain connector.

10. Make sure that the weight of the chandelier will be supported by the chain, not the electrical wire.

* You may now install the fixture.

Note: Complete these remaining steps after the fixture is hung.

11. Install the light bulbs (not provided) in accordance with the fixture's specifications.

(DO NOT EXCEED MAXIMUM WATTAGE RATING)

Fig 2

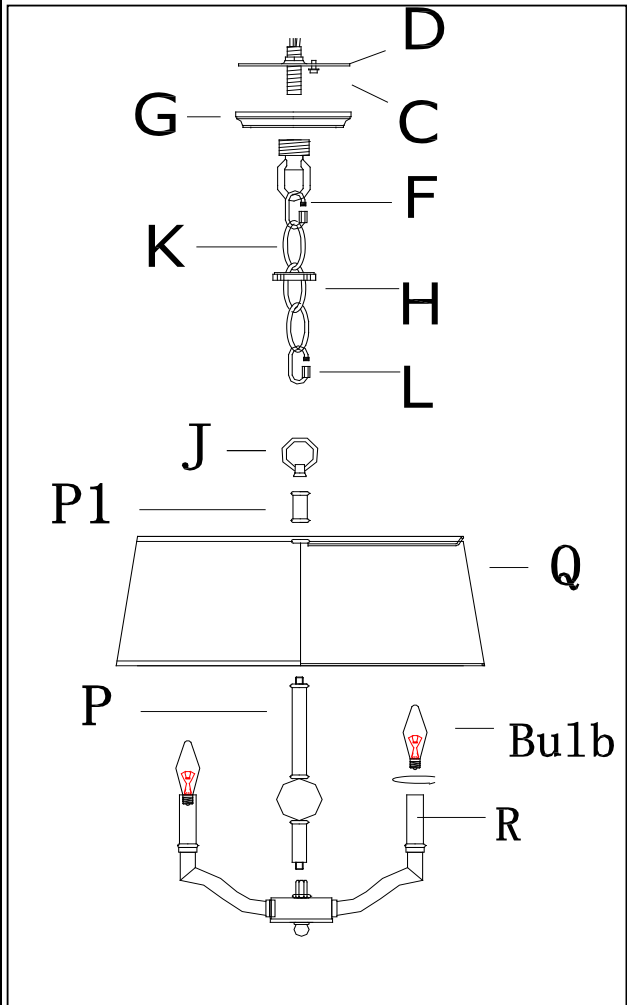

WARNING! SHUT OFF POWER AT FUSE OR CIRCUIT BREAKER.

HANGING THE FIXTURE as Semi flush (Fig. 1)

1. Carefully remove the new fixture from the carton and the yellow bag that holds all your parts. Check that all parts are included as shown in the illustration and Parts List.
2. Shut off power at the circuit breaker and completely remove the old fixture from ceiling, including the old mounting strap.
3. Circular Strap (B) contains several pairs of threaded holes. Find the pair of holes that matches the spacing of the holes in Canopy (F) and thread Mounting Screws (A) half way into the Mounting Strap (B) facing down. Secure in place with hex nuts. The threaded ends should protrude through the holes in Canopy (F).
4. Place Mounting Strap (B) over the junction box.
5. Attach the Mounting Strap (B) to the Junction Box using Mounting Screws (C). Tighten the screws securely with a screw driver.

Fig. 1

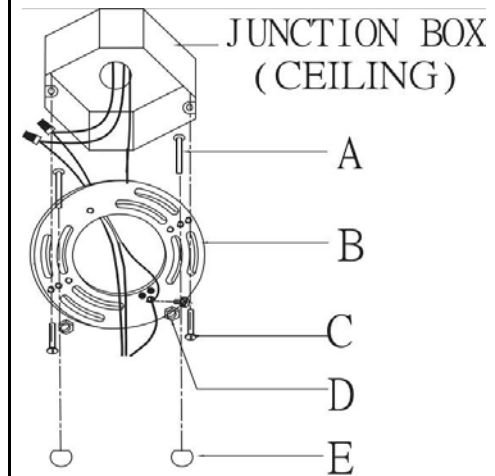

CONNECTING THE WIRES (Fig. 2)

6. Attach the power supply wires to the fixture lead wires by connecting BLACK to BLACK (or SMOOTH) and WHITE to WHITE (or RIBBED) .
 7. Ground wire connection: Connect the fixture ground wire to house ground wire, which usually has green or copper insulation, with the correct size of wire connector. If there is no house ground wire at ceiling junction box then attach fixture ground wire securely onto green grounding screw located on the mounting bar.
- NOTE: Twist the wires together in the same direction that you twisted the wire connector onto the wires.
8. Tuck the wire connections neatly into the Junction Box.

Fig. 2

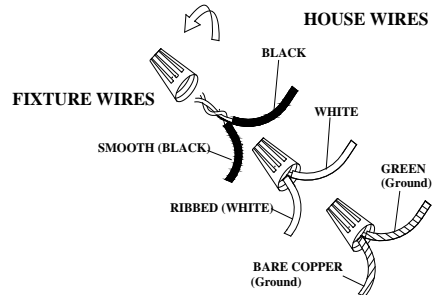

FINISHING THE INSALLATION (Fig.3)

9. Place Canopy (F) over Mounting Strap (B) and over the Mounting Screws (A). Adjust the canopy until Mounting Screws (A) protrude through canopy (D). Secure the fixture against the ceiling by threading the Decorative Nuts (E) until tight.
10. Install the light bulbs and glass shade as per the fixture assembly sheet.

Fig. 3

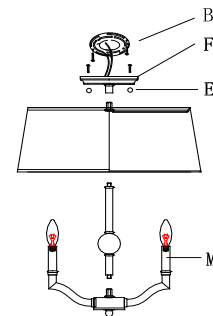

YOUR INSTALLATION IS NOW COMPLETE. RETURN POWER TO THE JUNCTION BOX AND TEST THE FIXTURE.



INSTALLATION INSTRUCTIONS

Fixture Name: Waverly 3500-SF AB

For Chandelier Light Fixture

WARNING ! SHUT OFF POWER AT FUSE OR CIRCUIT BREAKER.

HANGING THE FIXTURE (Fig. 1)

1. Carefully remove the new fixture from the carton and the yellow bag that holds all parts. Check that all parts are included as shown in the illustration and the Parts and Assembly Sheet.

2. Shut off the power at the circuit breaker and completely remove the old fixture from ceiling, including the old mounting strap.

3. Thread Nipple (C) into Canopy Loop (F) until snug.

4. Thread the other end of Nipple (C) with the canopy loop attached into Mounting Strap (D).

5. Place Lock Washer (B) over the end of Nipple (C). The end of Nipple (C) should protrude through Mounting Strap (D). Thread Hex Nuts (A) onto Nipple (C) until tight.

6. Take the mounting strap assembly and mount to the ceiling junction box with Junction Box Screws (E). Tighten the screws securely with a screw driver.

7. Unscrew Canopy Loop Collar (H) from Canopy Loop (F). Take the canopy and pass over the canopy loop. Approximately one half of the canopy loop's exterior threads should be exposed. Adjust until the desired height is reached.

*The Canopy loop collar should fit snugly on the Canopy loop after the canopy is installed. Remove Canopy and Canopy lock collar.

8. Assemble the fixture and have an assistant or a secure support to hold the weight of the fixture while you complete the wiring connections.

9. Thread the fixture wires and ground wire of the assembled fixture through the canopy loop and nipple and into the outlet box.

CONNECTING THE WIRES (Fig. 2)

10. Attach the power supply wires to the fixture lead wires by connecting BLACK to BLACK (or SMOOTH) and WHITE to WHITE (or RIBBED).

11. Attach the GROUND wire (GREEN or COPPER) from the Junction Box and the fixture ground wire to the green Ground Screw on Mounting Bracket (D) or connect both wires together using the correct size of wire connectors.

NOTE: Twist the wires together in the same direction you twisted the wire connector onto the wires.

12. Tuck these wire connections neatly into the Junction Box.

13. Raise Canopy (G) to the ceiling and secure in place by tightening Canopy Loop Collar (H) into the Canopy Loop (F).

14. Install the light bulbs and shade as per the fixture assembly sheet.

Fig. 1

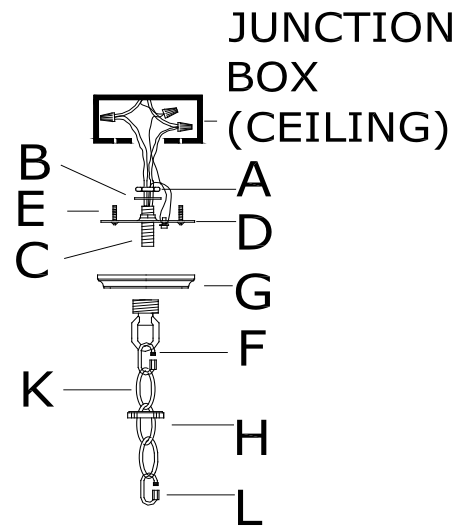
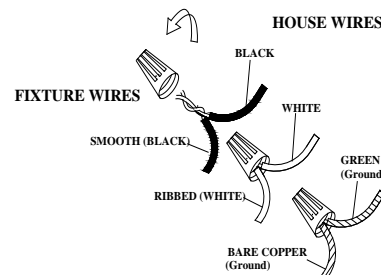

Fig. 2



YOUR INSTALLATION IS NOW COMPLETE. RETURN POWER TO THE JUNCTION BOX AND TEST THE FIXTURE.