

PTS700BN/FN/SN

GE Profile™ Series 30" Built-In Single Electric Convection Wall Oven

DIMENSIONS AND INSTALLATION INFORMATION (IN INCHES)

NOTE: Single wall ovens are NOT approved for stacking above or below another single wall oven.

NOTE: Wall coverings, countertops and cabinets surrounding the wall oven must be able to withstand a temperature of up to 200°F (94°C).

NOTE: If the cabinet in which the wall oven is installed does not have a solid bottom, two braces or runners must be installed to support the weight of the oven. The runners and braces must support up to 220 lbs (99 kg).

NOTE: Door handle protrudes 3" from door face. Cabinets and drawers on adjacent 45° and 90° walls should be placed to avoid interference with the handle.

ATTENTION INSTALLER: Electric wall ovens are NOT approved for installation with a plug and receptacle. They must be hard wired into an approved junction box.

IMPORTANT: Before installing, consult installation instructions packed with product for current dimensional data.

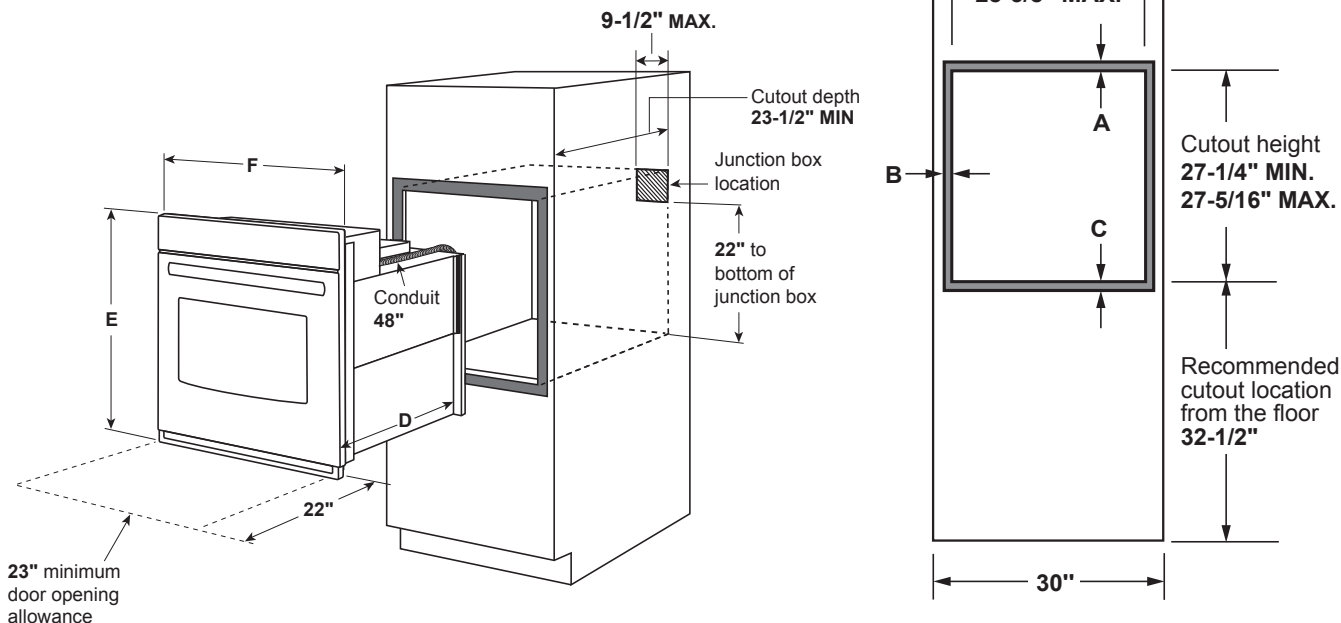

Dimension and installation information are shown in inches.

KW RATING	
240V	3.6
208V	2.7
BREAKER SIZE	
240V	20 Amps
208V	20 Amps

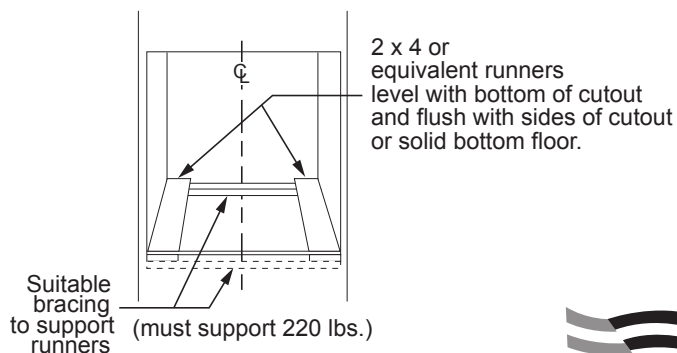

	PTS7000
Cabinet	30"
A - Overlap of oven at top of cutout	1"
B - Overlap of oven other side of edge of cutout	3/4"
C - Overlap of oven at bottom of cutout	1-1/4"
Oven	
D - Install depth	23-1/2"
E - Overall height with trim	28-5/8"
F - Overall width	29-3/4"



For answers to your GE Profile™ Series or GE Appliances product questions, visit our website at geappliances.com or call GE Answer Center® Service, 800.626.2000.



Listed by Underwriters Laboratories



PTS700BN/FN/SN

GE Profile™ Series 30" Built-In Single Electric Convection Wall Oven

DIMENSIONS AND INSTALLATION INFORMATION (IN INCHES)

NOTE: 30" Single electric wall ovens are approved for installation below a countertop, and below certain gas and electric cooktops. Refer to the Approved Combinations Matrix available at geappliances.com for specific information.

NOTE: 30" Single electric wall ovens are approved for installation above 27" and 30" warming drawers.

ATTENTION INSTALLER: Electric wall ovens are NOT approved for installation with a plug and receptacle. They must be hard wired into an approved junction box.

IMPORTANT: Before installing, consult installation instructions packed with ALL products for current dimensional and combination data.

UNDERCOUNTER INSTALLATION

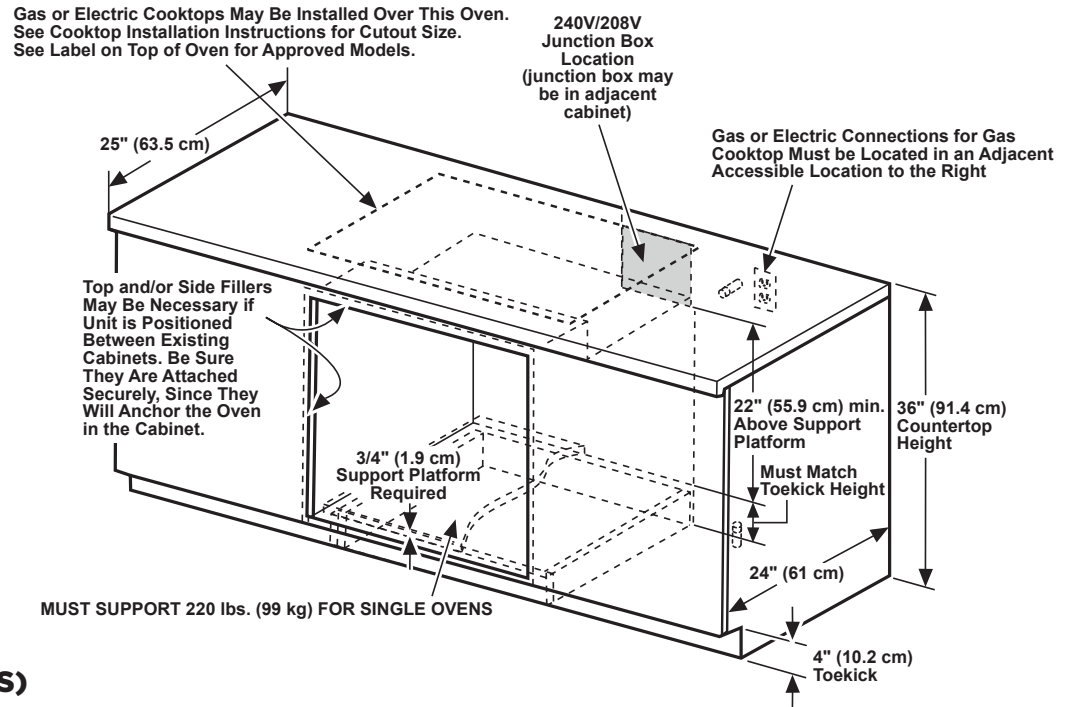

SIDE-BY-SIDE INSTALLATION (TWO OVENS IN SEPARATE CUTOUTS)

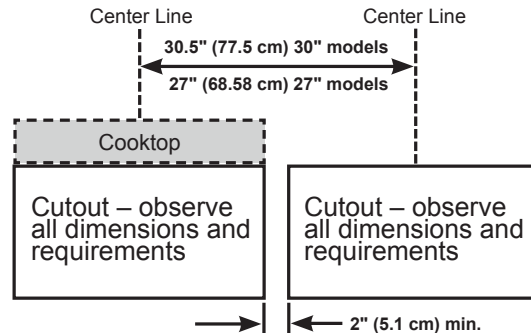

NOTE: One cooktop may be centered over either oven in the side-by-side installation.

INSTALLATION BELOW A COOKTOP

IMPORTANT: Maintain a minimum distance of 31 1/4" from the top surface of the countertop to the wall oven platform to ensure that the cooktop and wall oven do not interfere with each other (see picture).

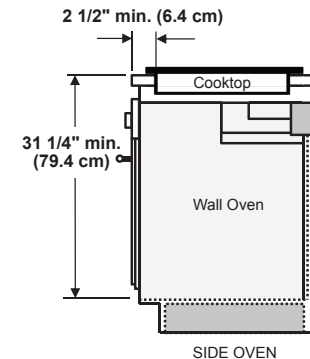

For answers to your GE Profile™ Series or GE Appliances product questions, visit our website at geappliances.com or call GE Answer Center® Service, 800.626.2000.

PTS7000BN/FN/SN

GE Profile™ Series 30" Built-In Single Electric Convection Wall Oven

FEATURES AND BENEFITS

Precision cooking modes – Skip the oven hover, even when cooking the most intricate dishes, thanks to advanced technology that provides step-by-step instructions and automatic adjustments to oven temperatures and cook times for perfect results

Brilliant Touch 7" Display – A bright, interactive touch screen makes it fun and easy to program the oven

True European Convection with Direct Air – Optimize your results on roasts, chicken, turkey and other special-occasion favorites, with the only cooking system that delivers true top-down convection

No preheat options – Save time with a variety of precision cooking modes that eliminate the need for preheating

Hot air frying – Achieve crispy, never greasy, fried food results in your oven without the oil

Anywhere control with remote notifications – Save time by conveniently preheating and monitoring your oven from anywhere using the GE Appliances Kitchen app

Never scrub, heavy-duty smooth glide racks – Easily remove even the heaviest dishes with a roller rack that's engineered to glide seamlessly out of the oven

Scan-to-cook technology – Prepare your favorite packaged foods to perfection simply by scanning the barcode on the package with your smartphone and letting your oven adjust settings automatically

Self-clean oven with optional Steam Clean – Let your oven do the cleaning for you with two ways to eliminate baked on messes

Model PTS7000BNTS – Black Stainless

Model PTS7000FNDS – Black Slate

Model PTS7000SNSS – Stainless Steel



FIT GUARANTEE

Replacing a similar wall oven from GE Appliances or another brand? GE wall ovens are guaranteed for an exact fit or GE Appliances will pay up to \$300 toward modifications.

Visit geappliances.com for more info

