

**DESIGN COPYRIGHT – 12/21/2022**  
 ALL RIGHTS RESERVED AND MAY  
 NOT BE DUPLICATED WITHOUT OUR  
 WRITTEN PERMISSION

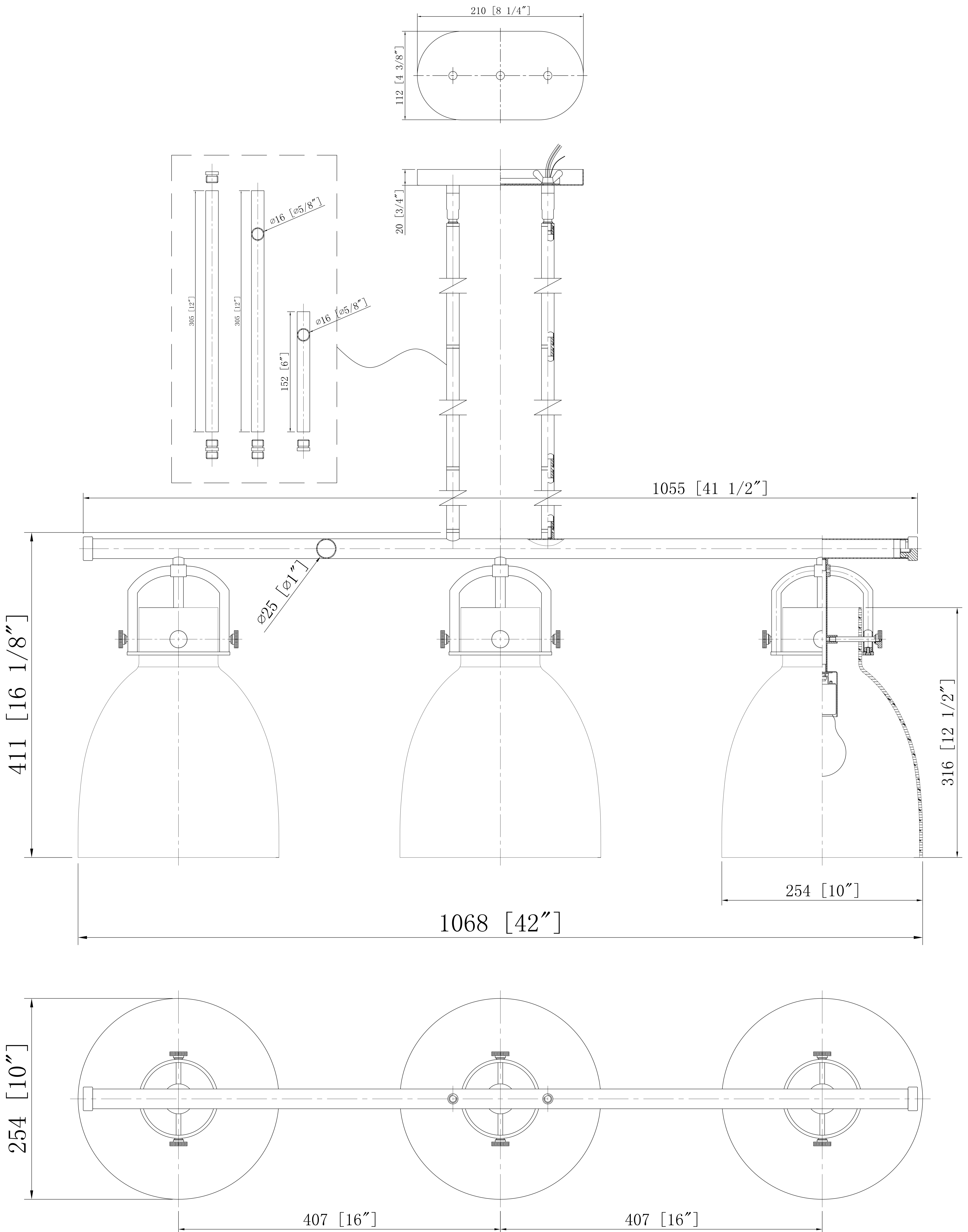

**ITEM: 412-3I-10**