

$\phi 10$ [$\phi 3/8$ "]

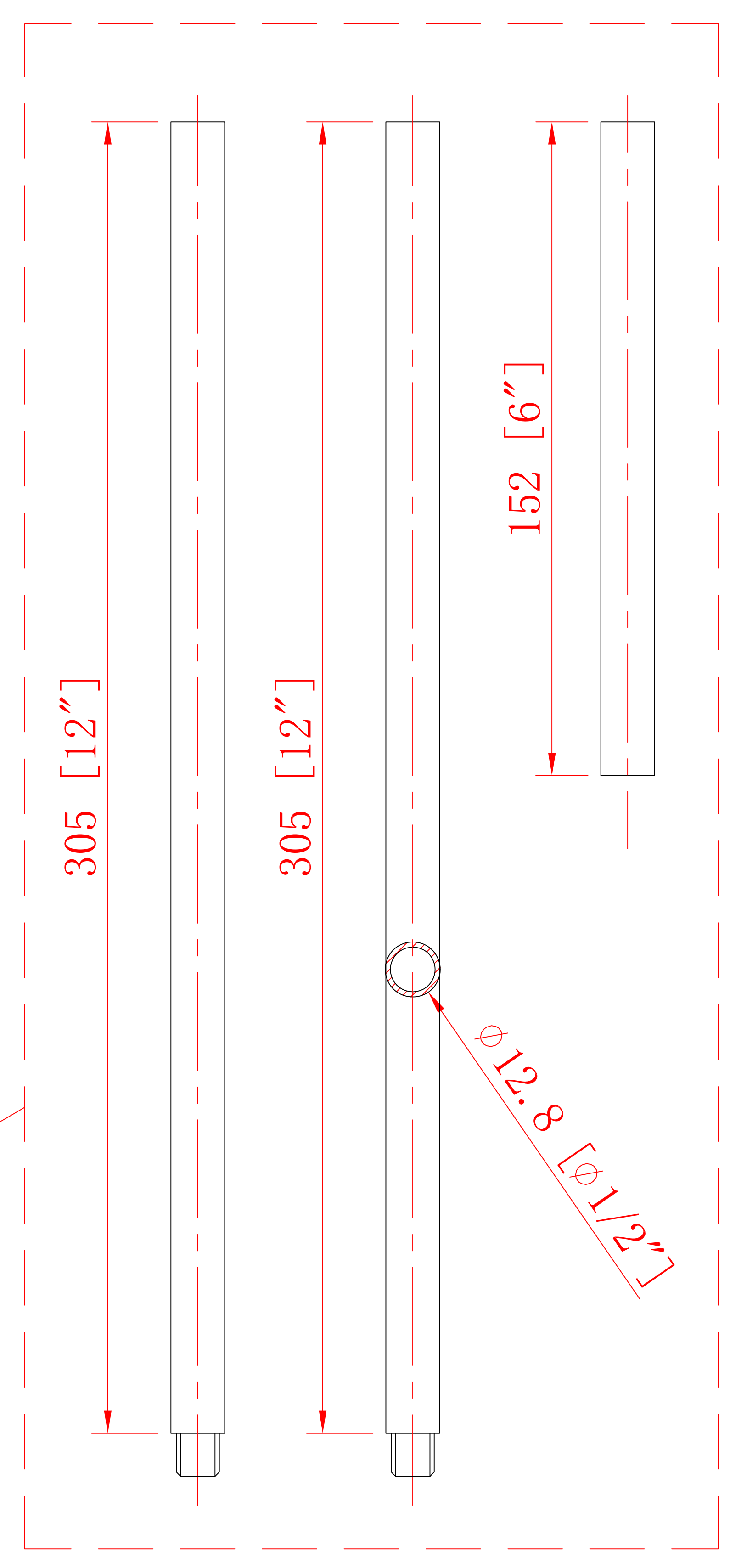
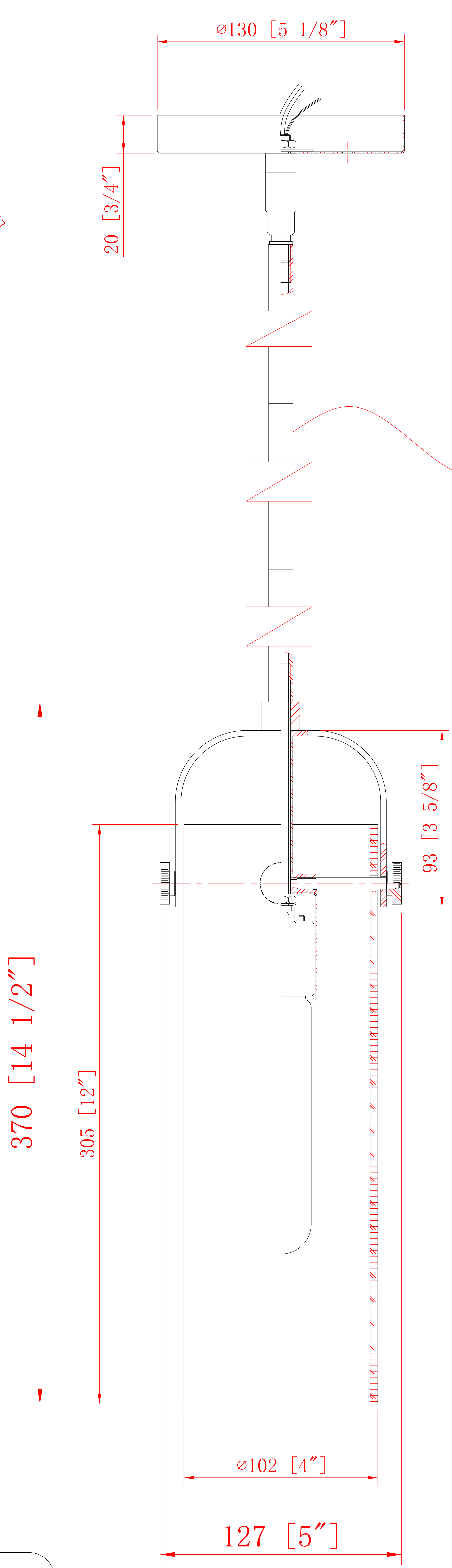

INNOVATIONS LIGHTING
 DESIGN COPYRIGHT - 03/12/2021
 ALL RIGHTS RESERVED AND MAY
 NOT BE DUPLICATED WITHOUT OUR
 WRITTEN PERMISSION

ITEM: 413-1S-4CL (IN 12INCH LENGTH)