

Lead Free Brass Ball Valve



2 Piece • Standard Port • Solder x Crimp Pex Connection •
400 WOG



S-412G

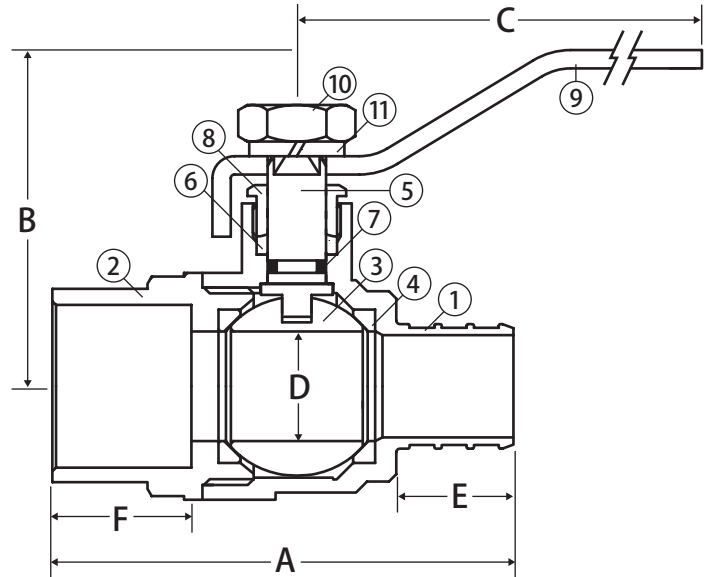

Features

- Dezincification resistant brass
- Gland follower and single o-ring stem design
- Blow-out proof stem
- 100% leak tested
- Wetted surfaces contain less than .25% lead content

Approvals



- ASTM F1807
- IAPMO Certified
 - NSF 61-8
 - NSF 372
 - Uniform Plumbing Code (cUPC)
 - IAPMO/ANSI Z1157-2014
 - NSF/ANSI 14-2014
- ASME/ANSI B16.18
- RoHS Compliant

Pressure Rating

- Body rated to 400 WOG
- Crimp connection rated to 100 WOG up to 180°F



WARNING: This product can expose you to chemicals including lead, which is known to the State of California to cause cancer, and lead, which is known to the State of California to cause birth defects or other reproductive harm. For more information go to www.P65Warnings.ca.gov.

Material Specifications

No.	Part	Materials
1	Body	Lead Free Brass - C46500
2	End Connection	Lead Free Brass - C46500
3	Ball	Lead Free Brass - C46500
4	Seat (2)	PTFE
5	Stem	Lead Free Brass - C46500
6	Packing	PTFE
7	Stem O-ring	Buna-N
8	Packing Gland	Lead Free Brass - C46500
9	Handle	Steel - Chrome Plated
10	Handle Nut	Steel - Chrome Plated
11	Lock Washer	Steel - Chrome Plated

Dimensions

Part No.	Size	A	B	C	D	E	F
103-533PG	1/2"	2.05	1.65	3.54	0.35	0.63	0.51
103-534PG	3/4"	2.48	1.72	3.54	0.53	0.63	0.75
105-535PG	1"	3.05	1.95	4.29	0.71	0.80	0.86