

FLATIRON MPU-652SB



*Custom ADA compliant versions are available

• FEATURES

- 16-gauge type 304 stainless steel
- 90° zero radius design

• TECHNICAL INFORMATION

- External dimension: 38"Lx18.5"Wx10"D
- Basin dimensions: 21"Lx16.5"Wx10"D
- Prepboard: 15"

• FINISHES

- Satin Brushed stainless steel

• INSTALLATION OPTIONS

- Top-mount
- Under-mount

• MINIMUM CABINET SIZE (I.D.)

- Top-mount 38"
- Under-mount 40"

• DUAL-MOUNT INSTALLATION

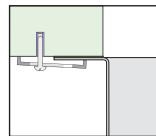

Under-mount

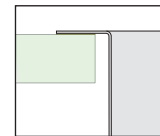

Top-mount

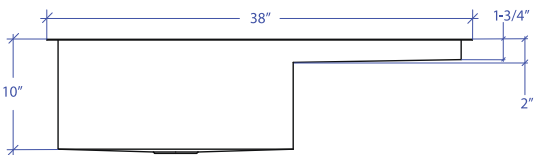
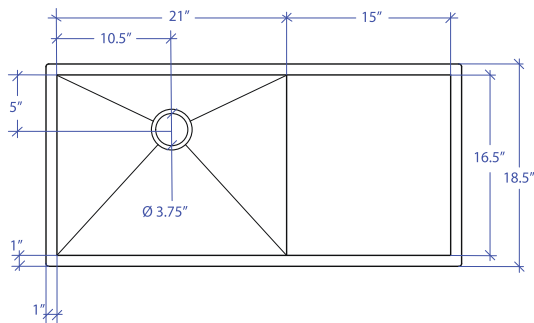

• ACCESSORY OPTIONS

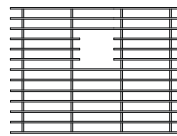

MBG-6508SB
Basin Grid

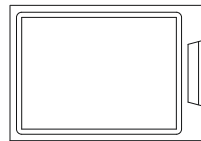

MCB-651BB
Cutting Board

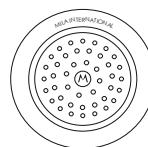

MKD-101SB
Strainer

PROJECT INFORMATION

Project			
Date	/ /	QTY	
Specifier			
Contact			
Note			