

## Operating and Installation Instructions Ventilation Hood



To prevent accidents and damage to the appliance, you **must** read these instructions before installing the appliance and using it for the first time.

# Contents

---

<b>IMPORTANT SAFETY INSTRUCTIONS</b> .....	4
<b>Guide to the appliance</b> .....	12
<b>Description of functions</b> .....	14
Con@ctivity 2.0 function.....	15
<b>Caring for the environment</b> .....	16
<b>Operation (Automatic mode)</b> .....	17
Cooking with Con@ctivity 2.0 (Automatic mode).....	17
Temporarily exiting Automatic mode.....	18
Resuming Automatic mode.....	18
<b>Operation (Manual mode)</b> .....	19
Cooking without Con@ctivity 2.0 (Manual mode) .....	19
Turning on the blower.....	19
Selecting the power level .....	19
Selecting the delayed shutdown time .....	19
Turning off the blower.....	19
Turning the overhead lighting on/off.....	19
Power management .....	20
Safety shut-off.....	20
<b>Operation (Automatic and Manual modes)</b> .....	21
Filter saturation indicator.....	21
Adjusting the grease filter filter saturation indicator .....	21
Activating/changing the charcoal filter saturation indicator .....	22
Checking the filter saturation indicator.....	22
<b>Cleaning and care</b> .....	23
Stainless steel housing.....	23
Important information for appliances with lacquered casing.....	23
Panels and grease filters for edge extraction .....	24
Replacing the grease filter.....	26
OdorFree Charcoal Filter .....	26
Resetting the filter saturation counter for the filter.....	27
Disposing of charcoal filters .....	27
<b>Installation</b> .....	28
Before installation.....	28
Removing the protective film.....	28
Installation materials.....	28
Appliance dimensions .....	30
Distance between cooktop and ventilation hood (S).....	31

Installation recommendations .....	32
Drilling diagram for wall mounting.....	32
Plywood backing .....	33
To install a plywood backing .....	33
Air venting .....	34
Non-return flap .....	34
Condensate .....	35
Reducing Collar .....	35
Electrical connection.....	36
<b>Activating Con@ctivity 2.0 .....</b>	<b>37</b>
Installation of the Con@ctivity 2.0 stick.....	37
Activating the Con@ctivity 2.0 function.....	37
Activating the ventilation hood.....	37
Activating the cooktop .....	38
Activation failed.....	38
Deactivating Con@ctivity 2.0.....	38
<b>Customer Service .....</b>	<b>39</b>
Contact in the event of a fault .....	39
Location of the data plate .....	39
<b>Technical data .....</b>	<b>40</b>
Optional accessories for recirculation mode.....	40

# IMPORTANT SAFETY INSTRUCTIONS

---

## READ AND SAVE THESE INSTRUCTIONS

This appliance complies with current safety requirements. Improper use of the appliance can lead to personal injury and material damage.

Read all instructions before installing or using the appliance for the first time. Only use the appliance for its intended purpose.

Keep these operating instructions in a safe place and pass them on to any future user.

### **Appropriate use**

- ▶ **CAUTION:** For General Ventilating Use Only. Do Not Use To Exhaust Hazardous Or Explosive Materials And Vapors.
- ▶ This appliance is intended for residential use only. Use only as described in these operating instructions.
- ▶ This ventilation hood is not intended for outdoor use.
- ▶ It must only be used to extract and clean vapors produced during cooking. Any other use occurs at the owner's own risk.
- ▶ Where a recirculation ventilation hood is installed above a gas cooktop, please check that all local codes are observed to insure an adequate supply of fresh air.
- ▶ This appliance is suitable for installation above gas or electric cooking surfaces.
- ▶ Persons who lack physical, sensory or mental abilities, or experience with the appliance should not use it without supervision or instruction by a responsible person.

# IMPORTANT SAFETY INSTRUCTIONS

---

## Safety with children

- ▶ Children must be kept away from the ventilation hood unless they are constantly supervised.
- ▶ Children must not be allowed to clean or service the hood.
- ▶ Please supervise children in the vicinity of the hood and do not let them play with it.
- ▶ The LED ClearView lighting is very intense.  
Avoid looking directly into the light for prolonged periods of time.
- ▶ Danger of suffocation. While playing, children may become entangled in packaging material (such as plastic wrapping) or pull it over their head, presenting the risk of suffocation. Keep packaging material away from children.

## Technical safety

- ▶ **WARNING: TO REDUCE THE RISK OF FIRE, ELECTRIC SHOCK, OR INJURY TO PERSONS, OBSERVE THE FOLLOWING:**
  - Use this appliance only in the manner intended by the manufacturer. If you have questions, contact Miele.
  - Before servicing or cleaning the appliance, switch power off at the service panel and lock the service disconnecting means to prevent power from being switched on accidentally. If the service disconnecting means cannot be locked, securely fasten a prominent warning device, such as a tag, to the service panel.
- ▶ Unauthorized installation, maintenance, and repairs can cause considerable danger for the user. Installation, maintenance, and repairs must only be carried out by a Miele authorized technician.
- ▶ A damaged ventilation hood can be dangerous. Always check for visible signs of damage. Never use a damaged ventilation hood.

## IMPORTANT SAFETY INSTRUCTIONS

---

- ▶ Be certain your appliance is properly installed and grounded by a qualified technician. To guarantee the electrical safety of this appliance, continuity must exist between the appliance and an effective grounding system. It is imperative that this basic safety requirement be met. If there is any doubt, have the electrical system of the house checked by a qualified electrician.
- ▶ Temporary or permanent operation on an autonomous power supply system or a power supply system that is not synchronized with the grid power supply (e.g., island networks, back-up systems) is possible. A prerequisite for operation is that the power supply system complies with national and local codes.  
The function and operation of the protective measures provided in the domestic electrical installation and in this Miele product must also be maintained in isolated operation or in operation that is not synchronized with the grid power supply, or these measures must be replaced by equivalent measures in the installation.
- ▶ To avoid damaging the ventilation hood, make sure that the connection data (voltage and frequency) on the data plate correspond to the building's power supply before connecting the appliance.  
If in doubt, consult a qualified electrician.
- ▶ Do not use a power bar or extension cord to connect the ventilation hood to electricity. These are a fire hazard and do not guarantee the required level of appliance safety.
- ▶ To ensure safe operation, only use the ventilation hood after it has been properly installed.
- ▶ This ventilation hood may not be used in non-stationary locations (e.g. on a ship).
- ▶ Adequate ventilation must be provided when the hood is operated simultaneously with devices that burn gas or other fuels.

## IMPORTANT SAFETY INSTRUCTIONS

---

▶ Only open the housing as described in the enclosed “Installation diagram” and in the “Cleaning and care” section of this manual. Under no circumstances should any other parts of the housing be opened. Tampering with electrical connections or components and mechanical parts is highly dangerous to the user and can cause operation faults.

▶ If the power cord is damaged, it must only be replaced by a qualified service technician.

▶ During installation, maintenance, and repair work, the ventilation hood must be disconnected from the electrical supply. It is only completely isolated from the electricity supply if one of the following applies:

- The circuit breakers on the electrical service panel are tripped.
- The screw-type fuses on the electrical service panel have been removed.
- The power cord (if present) has been unplugged from the socket (pull the plug not the cord).

### Correct use

▶ **WARNING: TO REDUCE THE RISK OF A COOKTOP GREASE FIRE:**

- a) Never leave surface units unattended at high settings. Boilovers cause smoking and greasy spillovers may ignite. Heat oils slowly on low or medium settings.
- b) Always turn the hood on when cooking at a high heat.
- c) Clean the ventilation hood frequently. Grease should not be allowed to accumulate on the fan or filter.
- d) Use the proper pan size. Always use cookware appropriate for the size of the cooking area.

▶ Open flames are a fire hazard.

The use of an open flame under the ventilation hood is not permitted. To avoid the danger of fire, do not flambé or grill over an open flame. When switched on, the ventilation hood could draw flames into the filter. Fat deposits could ignite, presenting a fire hazard.

## IMPORTANT SAFETY INSTRUCTIONS

---

▶ **WARNING: TO REDUCE THE RISK OF INJURY TO PERSONS IN THE EVENT OF A COOKTOP GREASE FIRE, OBSERVE THE FOLLOWING\*:**

- a) **SMOTHER FLAMES** with a close fitting lid, cookie sheet, or metal tray then turn off the burner. **BE CAREFUL TO PREVENT BURNS.** If the flames do not go out immediately, **EVACUATE AND CALL THE FIRE DEPARTMENT.**
- b) **NEVER PICK UP A FLAMING PAN** - You may be burned.
- c) **DO NOT USE WATER**, including wet dishcloths or towels - a violent steam explosion will result.
- d) Use a fire extinguisher **ONLY** if:
  - 1) You have a class ABC extinguisher, and you know how to operate it.
  - 2) The fire is small and contained in the area where it started.
  - 3) The fire department is being called.
  - 4) You can fight the fire with your back to an exit.

\*Based on “Kitchen Fire Safety Tips” published by NFPA.

▶ The ventilation hood may become damaged if exposed to excessive heat from a gas cooktop.

- When using the ventilation hood over a gas cooktop, ensure that any burners in use are always covered by cookware. Turn burners off when removing the cookware, even if doing so for just a short time.
  - Select cookware that is suitable for the size of the burner.
  - Adjust the flame so that it never extends up the sides of the cookware.
  - Avoid overheating the cookware (e.g., when cooking with a wok).
- ▶ Always turn the ventilation hood on whenever a burner is in use to prevent damage from condensation.
- ▶ Overheated oil and fat can ignite, causing fire damage to the ventilation hood.

Do not leave cookware, pans, and deep-fat fryers unattended when cooking with oil or fat. Similarly, never leave an open flame unattended when grilling.



# IMPORTANT SAFETY INSTRUCTIONS

---

▶ Fat and debris deposits impair the proper functioning of the ventilation hood.

To ensure that cooking vapors are properly cleaned, never use the ventilation hood without the grease filters in place.

▶ Please note that the heat rising from the stovetop during cooking can cause the ventilation hood to become very hot.

Do not touch the housing or the grease filters until the ventilation hood has cooled down.

## Proper installation

▶ **WARNING: TO REDUCE THE RISK OF FIRE, ELECTRIC SHOCK, OR INJURY TO PERSONS, OBSERVE THE FOLLOWING:**

- a) Installation work and electrical wiring must be done by qualified person(s) in accordance with all applicable codes and standards, including fire-rated construction.
  - b) Sufficient air is needed for combustion and exhausting of gases through the flue (chimney of fuel burning equipment to prevent back drafting. Follow the heating equipment manufacturer's guideline and safety standards such as those published by the National Fire Protection Association (NFPA) and the American Society for Heating, Refrigeration and Air Conditioning Engineers (ASHRAE), and the local code authorities.
  - c) When cutting or drilling into the wall or ceiling, do not damage electrical wiring and other hidden utilities.
  - d) Ducted hoods must always be vented to the outdoors.
  - e) Do not use this hood with any solid-state speed control device.
- ▶ To determine whether a ventilation hood may be operated above your cooking appliance, please refer to the information provided by the appliance's manufacturer.
- ▶ Safety regulations prohibit the installation of a ventilation hood over solid fuel stoves.

## IMPORTANT SAFETY INSTRUCTIONS

---

- ▶ An insufficient safety distance between the cooktop and the ventilation hood can result in damage to the ventilation hood. The minimum safety distances between the top of the cooktop and the bottom of the ventilation hood given in the “Installation” section of this manual must be observed, unless the cooktop manufacturer states that a greater safety distance is required. If more than one cooking appliance is installed beneath the ventilation hood, and they have different minimum safety distances to the ventilation hood, select the greater distance.
- ▶ The information provided in “Installation” must be observed when installing the ventilation hood.
- ▶ Components can have sharp edges which may cause injury. Wear gloves to protect your hands.
- ▶ When installing the exhaust duct, only use pipes or tubes made of non-flammable material. These can be obtained from your Miele dealer or from Miele Technical Service. Always observe local building code requirements when selecting duct material.
- ▶ Exhaust air should not be vented into a chimney or vent flue which is otherwise in use and should not be channeled into ducting which ventilates rooms with fuel-burning installations.
- ▶ If exhaust air is to be extracted into a chimney or ventilation duct no longer used for other purposes, seek professional advice.
- ▶ **WARNING: TO REDUCE THE RISK OF FIRE USE ONLY METAL DUCTWORK.**

### **Cleaning and maintenance**

- ▶ There is a risk of fire if cleaning is not completed according to the instructions in this manual.
- ▶ Never use a steam cleaner to clean the ventilation hood. The steam can reach the electrical components and cause a short circuit.

# IMPORTANT SAFETY INSTRUCTIONS

---

## Accessories and parts

- ▶ Use only genuine original Miele parts. If parts or accessories from other manufacturers are used, the warranty may become void.
- ▶ Defective components should be replaced by Miele original parts only. Only with these parts can safety of the appliance be assured as intended by the manufacturer.
- ▶ Miele will guarantee to supply functional parts for a minimum of 10 years and up to 15 years following the discontinuation of your ventilation unit.

## FCC Declaration of Conformity

- ▶ These devices comply with FCC Rules Part 15. This equipment has been tested and found to be in compliance with the limits for a Class B digital device, pursuant to Part 15 of the FCC Rules of Operation and is subject to the following conditions:  
These devices may not cause harmful interference.  
These devices must accept any interference received, including interference that may cause undesired operation.

## FCC Radiation Exposure Statement

- ▶ This equipment complies with FCC radiation exposure limits set forth for an uncontrolled environment. This equipment should be installed and operated with minimum distance 8" (20 cm) between the radiator and your body.

## Industry Canada Statement

- ▶ This digital apparatus does not exceed the Class B limits for Radio Noise Emissions from digital apparatus set out in the Radio Interference Regulations of the Canadian Department of Communications.

Complies with Canadian ICES-003 Class B specifications.

# Guide to the appliance

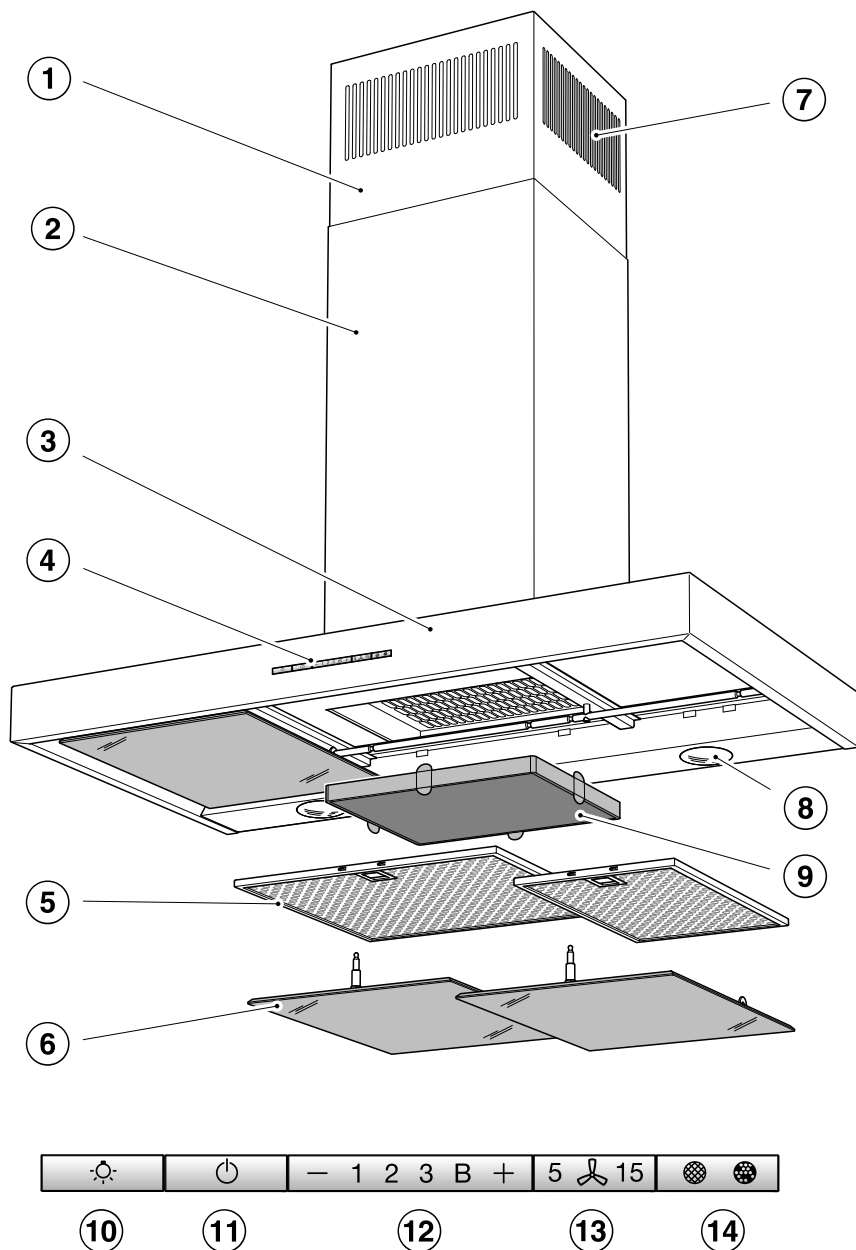

dai3255

- ① Telescopic chimney
- ② Chimney
- ③ Canopy
- ④ Control panel
- ⑤ Grease filter
- ⑥ Edge extraction panels
  - Optional accessories
  - DRP 6590 W glass (3 elements)
  - DRP 6590 W stainless steel (3 elements)
  - DRP 6520 W glass (4 elements)
  - DRP 6520 W stainless steel (4 elements)
- ⑦ Recirculation vent
  - (only for recirculation mode)
- ⑧ Cooktop lighting
- ⑨ OdorFree Charcoal Filter
  - Optional accessory for recirculation mode
- ⑩ Button for cooktop lighting
- ⑪ On/Off button for fan
- ⑫ Buttons for setting the fan power
- ⑬ Button for delayed shut-down function
- ⑭ Filter saturation indicator

# Description of functions

---

The following functions are available on your ventilation hood, depending on the model:

## Extraction mode



dafr0494a

The air is drawn into the ventilation hood. It is then cleaned by the edge extraction panels and the grease filters and directed outside.

## Recirculation mode

(Only DA 6596 W requires a Recirculation kit and OdorFree Charcoal Filter (available as optional accessories); see “Technical data” for more information.)



dafr0494b

The air is drawn in and cleaned first by the edge extraction panels and the grease filters, and then by a charcoal filter. The cleaned air is then recirculated back into the kitchen.

## Con@ctivity 2.0 function

### Automatic control

This hood features a communication function which enables the automatic control of the hood based on the operational status of a Miele induction cooktop.

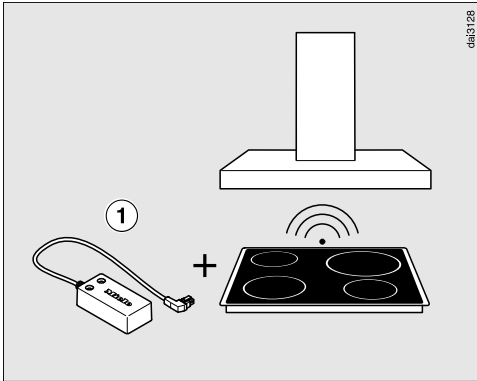

To enable the communication function, the cooktop must be equipped with the corresponding Con@ctivity 2.0 stick ①.

Please refer to the installation instructions for the Con@ctivity 2.0 stick to determine whether connection to your cooktop is possible.

There must be radio contact between the cooktop and the hood for you to be able to use the Con@ctivity 2.0 function (see “Activating Con@ctivity 2.0”).

The cooktop transmits information about its operational status to the hood using a radio signal.

- When a burner is turned on, the cooktop lighting on the hood turns on automatically. After a brief delay, the ventilation hood fan also comes on.
- During cooking, the hood automatically selects the fan level based on the number of burners in operation and their power levels.
- Once you have turned off the cooktop, the fan and the lighting will turn off automatically after a predetermined delay.

Detailed information about this function can be found under “Operation.”

# Caring for the environment

---

## **Disposal of the packing material**

The cardboard box and packing materials protect the appliance during shipping. They have been designed to be biodegradable and recyclable.

Ensure that any plastic wrappings, bags, etc. are disposed of safely and kept out of the reach of children.  
Danger of suffocation!

## **Disposal of your old appliance**

Do not dispose of this appliance with your household waste.

Old appliances may contain materials that can be recycled. Please contact your local recycling authority about the possibility of recycling these materials.

Before discarding an old appliance ensure that it presents no danger to children while being stored for disposal. Unplug it from the outlet, cut off its power cord and remove any doors to prevent hazards.



# Operation (Automatic mode)

When Con@ctivity 2.0 is active, the hood always operates in Automatic mode (see “Activating Con@ctivity 2.0”).

See “Cooking without Con@ctivity 2.0” for information on manually operating the hood.

## Cooking with Con@ctivity 2.0 (Automatic mode)

- Turn on a burner to the desired power setting.

Overhead cooktop lighting.

After a few seconds, the fan will come on, briefly operating at power level **2** before immediately switching to level **1**.

The hood selects the fan level automatically during cooking.

This level is determined by the total output of the cooktop, i.e. the number of burners in operation and the power settings selected.

- If you select a higher power setting on the cooktop or switch on multiple burners, the hood will switch to a higher fan level.
- If you select a lower power setting on the cooktop or turn off a burner, the hood will accordingly switch to a lower fan level.

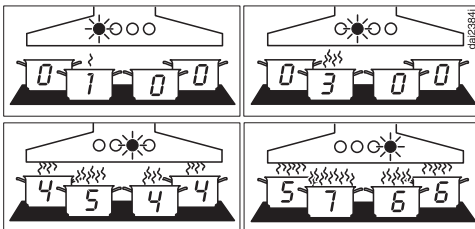

Examples for fan levels **1** to **4**

## Reaction time

Changing the power setting on the cooktop does not lead to an immediate increase or decrease in cooking vapors. For this reason, the hood reacts with a slight delay.

Delays can also result from the fact that the cooktop transmits the information to the hood in intervals.

The reaction time can vary from a few seconds to a couple of minutes.

## Cooking process

- If, for example, you switch on a burner at the highest power setting to heat cookware in preparation for searing and then reduce the power level after approx. 60 to 90 seconds, a cooking process is recognized.

The hood turns on automatically and, after the cooktop power level has been reduced, switches back to fan level 3, where it remains for approx. 5 minutes.

After this, the fan level is once again determined by the Con@ctivity function.

- You can also manually select a different fan level before then.

# Operation (Automatic mode)

---

## Switching off

- Turn off all burners.

Over the next few minutes, the ventilation hood blower setting will decrease one level at a time until the hood eventually turns off.

This helps to neutralize any lingering vapors and odors in the air.

- From the Booster setting, the blower switches immediately to level 3.
- From level 3, it will switch to level 2 after approx. 1 minute.
- From level 2, it will switch to level 1 after 2 minutes.
- After 2 minutes at level 1, the blower automatically turns off.
- After another 30 seconds, the overhead lighting turns off.

The cooking process is then finished.

## Temporarily exiting Automatic mode

To temporarily exit the Automatic mode when cooking:

- Manually select a different fan level, or
- Manually turn the hood off, or
- Activate the Delayed shut down function  on the ventilation hood. The fan turns off after the delay time selected, and the lighting will remain on.

The ventilation hood functions can now be operated manually (see “Cooking without Con@ctivity 2.0”).

## Resuming Automatic mode

The ventilation hood resumes Automatic mode:

- If the ventilation hood has not been used for a period of approx. 5 minutes after the manual selection of a fan level, or
- If the manually selected fan level once again matches the automatic setting, or
- If the ventilation hood fan and the cooktop have been turned off for at least 30 seconds. Automatic mode will resume the next time the cooktop is turned on.
- If you wish to manually operate the ventilation hood for a complete cooking process, turn on the ventilation hood fan **before** turning on the cooktop. If the ventilation hood and the cooktop have been turned off for at least 30 seconds after you have finished cooking, Automatic mode will resume the next time the cooktop is turned on.

## Cooking without Con@ctivity 2.0 (Manual mode)

The hood can be operated manually if:

- The Con@ctivity 2.0 function is not activated.
- You have temporarily deactivated the Con@ctivity 2.0 function (see “Temporarily exiting Automatic mode”).

## Turning on the blower

Switch the blower on as soon as you start cooking. This is to ensure that vapors are captured right from the start.

- Press the On/Off control .

The blower turns on at level **2**. The  symbol and **2** will light up in the blower level display.

## Selecting the power level

Power levels **1** to **3** are available for light to heavy cooking vapors and odors.

For strong vapors and odors that are temporarily produced when cooking, e.g., during searing, select the **B** Booster setting.

- Select the power level you want by pressing the **-** or **+** control.

## Reducing power down from the Booster setting



If power management is activated (default setting), the blower automatically switches back to level **3** after 5 minutes.

## Selecting the delayed shutdown time

It is advisable to run the blower for a few minutes after cooking has finished. This helps to neutralize any lingering vapors and odors in the air.

It also reduces the risk of odors and residues accumulating in the ventilation hood.

The delayed shutdown function enables the blower to continue running for a pre-determined time before switching itself off automatically.

- After you have finished cooking, press the delayed shutdown control  while the blower is still running.
- Once: blower turns off after 5 minutes (**5** lights up).
- Twice: blower turns off after 15 minutes (**15** lights up).
- If you touch the delayed shutdown control  again, the blower will remain switched on ( will go out).

## Turning off the blower

- Press the On/Off control  to turn the blower off.

The  symbol will go out.

## Turning the overhead lighting on/off

The overhead lighting can be turned on and off separately from the blower.

- To do this, press the lighting control .

The  symbol will light up when the overhead lighting is turned on.

# Operation (Manual mode)

---

## Power management



The ventilation hood is equipped with a power management system. Power management helps to save energy. It ensures that the blower power level is reduced automatically and that the lighting is switched off.

- If the booster level is selected, the blower automatically switches to level 3 after 5 minutes.
- If the blower is set to level 3, 2, or 1, it switches back one blower setting after 2 hours and then in 30-minute intervals until the blower eventually switches off.
- The overhead lighting will switch off automatically after 12 hours.

You can deactivate power management.

Keep in mind that this may increase energy consumption.

## Activating/deactivating power management

- Switch off the blower and the lighting.
- Press the delayed shutdown control  for approx. 10 seconds until the **1** indicator appears in the blower level display.
- Then press, in turn:
  - the lighting control ,
  - the — control, and then
  - the lighting control .

When power management is turned on, the **1** and **B** indicators will be continuously lit.

When it is turned off, the **1** and **B** indicators will flash.

- Press the — control to deactivate power management.

The **1** and **B** indicators will flash.

- Press the + control to activate power management.

The **1** and **B** indicators will be continuously lit.



- Confirm the setting by pressing the delayed shutdown control .

All the indicator lights will go out.

If you do not confirm the new setting within 4 minutes, the ventilation hood will revert to the previous setting.

## Safety shut-off



If power management has been deactivated, the ventilation hood will switch itself off automatically after 12 hours if it has been left on (blower and overhead lighting).

- To switch it back on, press the On/Off  control or the lighting control .

# Operation (Automatic and Manual modes)

## Filter saturation indicator

The ventilation hood registers the length of time it has been operated.



The filter saturation indicators show when the filters need to be cleaned or changed by lighting up the grease filter symbol  or charcoal filter symbol . Additional information on cleaning and changing the filters and resetting the filter saturation indicators can be found under “Cleaning and care”.

## Adjusting the grease filter filter saturation indicator

The filter saturation indicator can be set to suit the customer’s cooking habits.

The factory default setting is a cleaning interval of 30 hours.



- Select a shorter interval of 20 hours if food is fried regularly.
- A shorter cleaning interval is also recommended if the customer only cooks occasionally. This will prevent grease buildup from hardening and making cleaning more difficult.
- Select a longer cleaning interval of 40 or 50 hours if the customer uses very little fat when cooking.

- Switch off the blower and the lighting.
- Press the delayed shutdown control <sup>5</sup> and the filter saturation control   at the same time.

The grease filter symbol  and one of the blower power level indicators will flash.

The indicators **1** to **B** show the current time setting:

<b>1</b> .....	20 hours
<b>2</b> .....	30 hours
<b>3</b> .....	40 hours
<b>B</b> .....	50 hours

- Press the **—** control for a shorter duration, or **+** for a longer duration.
- Confirm the selection by pressing the filter saturation indicator  .

All the indicator lights will go out.



If the new setting is not confirmed within 4 minutes, the ventilation hood will revert to the previous setting.

## Operation (Automatic and Manual modes)

### Activating/changing the charcoal filter saturation indicator

The charcoal filter is required for the recirculation mode.



The filter saturation indicator for the charcoal filter must be activated once and should be set to match your cooking habits.

- Press the On/Off button  to turn the blower off.
- Press the “+” symbol and the filter saturation indicator   at the same time.

The charcoal filter symbol  and one of the blower power level indicators will flash.

The indicators **1** to **B** show the current time setting:

Indicator <b>1</b> .....	120 hours
Indicator <b>2</b> .....	180 hours
Indicator <b>3</b> .....	240 hours
Indicator <b>B</b> .....	deactivated





- Press the “-” symbol for a shorter operating time, or the “+” symbol to select a longer operating time.
- Confirm the selection by pressing the filter saturation indicator  .

All the indicator lights go out.

If the new setting is not confirmed within 4 minutes, the hood reverts to the previous setting.

### Checking the filter saturation indicator

Before the set operating time has run out, you can check what percentage of the time has elapsed.

- Press the On/Off control  to turn the blower on.
- Press and hold the filter saturation indicator  .
- Once, to check the grease filter operating time. The grease filter symbol  lights up.
- Twice, to check the charcoal filter operating time. The charcoal filter symbol  lights up.

One or more of the blower power level indicators will flash simultaneously.

The number of flashing indicators shows the elapsed operating time as a percentage.

Indicator <b>1</b> .....	25%
Indicators <b>1</b> and <b>2</b> .....	50%
Indicators <b>1</b> to <b>3</b> .....	75%
Indicators <b>1</b> to <b>B</b> .....	100%

The number of elapsed operating hours remains stored in memory when the ventilation hood is turned off or if there is a power outage.

 **WARNING: TO REDUCE THE RISK OF FIRE, ELECTRIC SHOCK, OR INJURY TO PERSONS, OBSERVE THE FOLLOWING:**

- Before cleaning or servicing the hood, disconnect it from the power supply, see “IMPORTANT SAFETY INSTRUCTIONS”.

## Stainless steel housing

### General information

Unsuitable cleaning agents can damage the surfaces and control elements.

Do not use any cleaning agents containing soda, acid, chloride, or solvent.

Do not use any abrasive cleaning agents, e.g., powder cleaners or cream cleaners and abrasive sponges, as well as pot scourers or sponges which have been used previously with abrasive cleaning agents

 Moisture in the ventilation hood can cause damage.

Make sure that water does not get into the ventilation hood.

- Clean all surfaces and control buttons using a small amount of warm water and liquid dish soap. Apply with a sponge cloth.
- After cleaning, wipe the surfaces dry using a soft cloth.

### Important information for appliances with stainless steel surfaces

This information does not apply to the control buttons.

Stainless steel surfaces can be cleaned with a non-abrasive cleaning agent designed specifically for use on stainless steel.

To prevent the surfaces from quickly becoming dirty again, we recommend treating them with a stainless steel care product (available from Miele).

### Important information for appliances with lacquered casing

(Customization on request)

Minor scratches on the surface are inevitable when cleaning the casing; they may be visible depending on the lighting in the kitchen.

### Important information for the controls

If soiling is not removed promptly, it could cause the control elements to alter or discolor.

Remove soiling immediately.

The surface of the control elements can become damaged if they are cleaned using stainless steel cleaning agents.

Do not use stainless steel cleaning agents on the control elements.

# Cleaning and care

## Panels and grease filters for edge extraction

The edge extraction panels and the reusable metal grease filters in the appliance remove solid particles (grease, dust, etc.) from the kitchen vapors, preventing soiling of the hood.

### Risk of fire

Oversaturated grease filters are a fire hazard.

Clean the grease filters at regular intervals.

## Cleaning intervals

The grease filters and panels should be cleaned regularly (at least every 3-4 weeks) to avoid a buildup of grease.

Clean the edge extraction panels and grease filter immediately if the grease filter symbol  on the filter saturation indicator lights up.

- You can adjust the interval of the filter saturation indicator to match your cooking habits (see “Operation”).

## Removing the panels and grease filters

 The grease filters and panels can fall out when you are handling them.

This can result in damage.

Make sure you hold the filters and panels securely at all times when handling them.

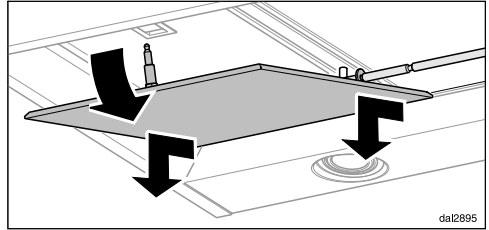

- Pull the front edge of the panels down out of the lock, lower them slightly, unhook them at the back, and take them out.

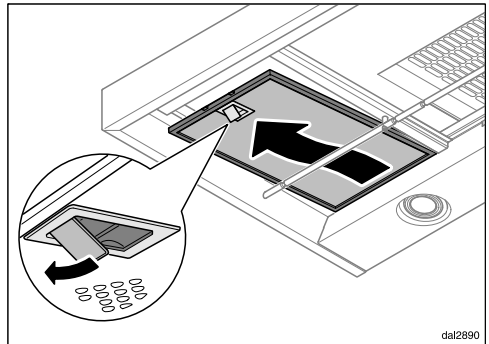

- To remove a grease filter, release the locking clip. Then, open the filter to a 45° angle, unhook it, and remove it from the hood.

## Cleaning the panels by hand

- Follow the instructions under “Housing.”

## Cleaning the grease filters by hand

- Clean the filters with a soft nylon brush in a mild solution of hot water and dish soap. Do not use undiluted dish soap.



## Unsuitable cleaning agents

Unsuitable cleaners can cause damage to the filter surfaces if used regularly. Do not use any of the following:

- Lime removers
- Abrasive powders or abrasive liquids
- Aggressive all-purpose cleaners and degreaser sprays
- Oven sprays

## Cleaning the panels and grease filters in the dishwasher

- Place the panels and filters as upright or inclined as possible in the lower basket. Ensure that the spray arm is not obstructed.
- Use a household dishwasher detergent.
- Select a program with a wash temperature between 122°F (50°C) and 149°F (65°C).

Depending on the detergent used, cleaning the filters in a dishwasher may cause the inside filter surfaces to become discolored. However, this will not affect the functioning of the filters in any way.

## After cleaning

- After cleaning, leave the filters on an absorbent surface to dry.
- When removing the panels and grease filters for cleaning, also clean off any accessible oil or grease buildup from the housing. Doing so will prevent a fire hazard.

- Reinstall the grease filters. When inserting the filters, make sure that the locking clip is facing down.

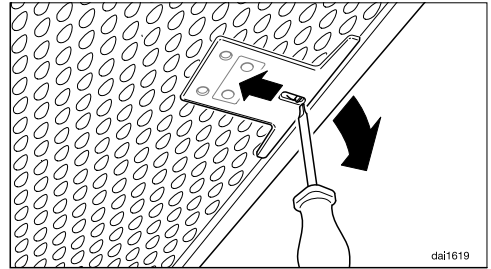

- If the filters have been installed incorrectly, you can insert a small screwdriver into the slit to disengage the locking clip.
- Hook the panels onto the support rod.
- Lift up the front of the panels and push them into the lock until they engage.

## Resetting the filter saturation indicator for the grease filters

Once cleaning is complete, the filter saturation indicator must be reset.

- While the blower is turned on, press the filter saturation indicator  for approx. 3 seconds until **1** is the only indicator flashing.

The grease filter symbol  goes out.

When cleaning the grease filters before the full operating time has elapsed:

- Press the filter saturation indicator  for approx. 6 seconds until **1** is the only indicator flashing.

# Cleaning and care

## Replacing the grease filter

Regular usage and cleaning can cause the filter surfaces to become worn.

If you identify any damage, replace the grease filters.

Grease filters are available to order via Miele Customer Service (see end of these operating instructions for contact details) or from your Miele dealer.

## OdorFree Charcoal Filter

With recirculation mode, a charcoal filter must be installed in addition to the grease filters. The charcoal filter is designed to absorb cooking odors.

The charcoal filter is installed in the canopy above the grease filters.

Charcoal filters are available to order via the Miele Web Store, Miele Technical Service (see end of this manual for contact details), or from your Miele dealer. The model designations are listed in the “Technical data” chapter.

## Installing/replacing the OdorFree Charcoal Filter

- To install or replace the OdorFree Charcoal Filter, the grease filters must first be removed as described above.
- Remove the OdorFree Charcoal Filter from its packaging.

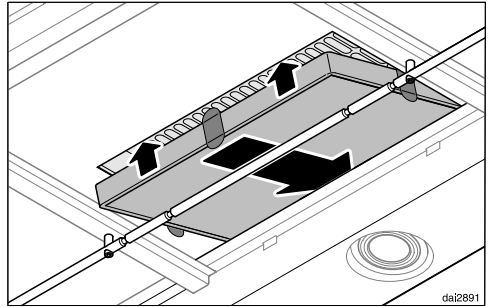

- Slide the filter into the back of the intake frame, then push the front of the filter up into the frame.
- Reinsert the grease filters and the panels.
- When installing the filter for the first time, activate the filter saturation counter (see “Operation”).

## When to change the OdorFree Charcoal Filter



- Replace the charcoal filter when it no longer absorbs kitchen odors effectively. It should be replaced at least every 6 months.

The OdorFree Charcoal Filter saturation counter 🌐 will light up to remind you to change the charcoal filter regularly.

- The OdorFree Charcoal Filter saturation counter requires one-time activation before use (see the “Operation” chapter).

## Resetting the filter saturation counter for the filter

If the filter saturation counter is activated, it must be reset each time the filter is changed.

- To do this, press the filter saturation indicator  twice with the fan turned on and hold it for approx. 3 seconds until **1** is the only indicator flashing. The OdorFree Charcoal Filter symbol  will go out.

If you replace the OdorFree Charcoal Filter **before** the full operating time elapses:

- Press the filter saturation indicator  twice and hold it for approx. 6 seconds until **1** is the only indicator flashing.

## Disposing of charcoal filters

- Used charcoal filters can be disposed of with normal household waste.

# Installation

## Before installation

 Before installing the appliance, read all of the information contained in this chapter and also in the “IMPORTANT SAFETY INSTRUCTIONS” section.

## Removing the protective film

The housing components are covered by a protective film to prevent them from damage during transport.

- Please remove this film before installing the housing components. It can be peeled off easily without any additional tools.

## Installation materials

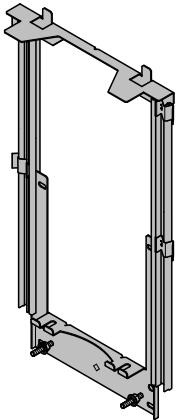

**Telescopic wall bracket**  
for securing the ventilation system on the wall.

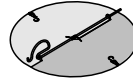

### 1 non-return flap

for fitting into the exhaust socket on the motor unit (not needed for recirculation mode). Depending on the model, the non-return flap may already be mounted.

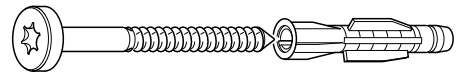

### 6 screws 5 x 60 mm and 6 plugs 8 x 50 mm

for securing the ventilation hood on the wall.

 The screws and plugs are designed for use in solid walls only. Use different fasteners for other wall construction types. Make sure that the wall can support the load.



### 2 M6 locknuts

for mounting the appliance unit



### 2 screws 3.9 x 7.5 mm

for securing the duct cover

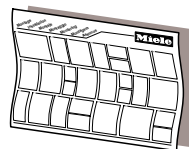

08169470

5/6/2016 10:08:00

00031652

08256130

d/ha3mle

08561000

## Installation plan

See the installation plan for details of the individual steps involved in the installation of this appliance.

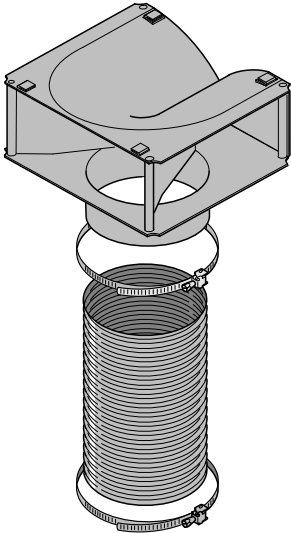

DJW20

## Conversion kit for recirculation mode

The conversion kit contains an exhaust grille, hose, and hose clips (not supplied, but available as an optional accessory. See “Technical data”).

# Installation

## Appliance dimensions

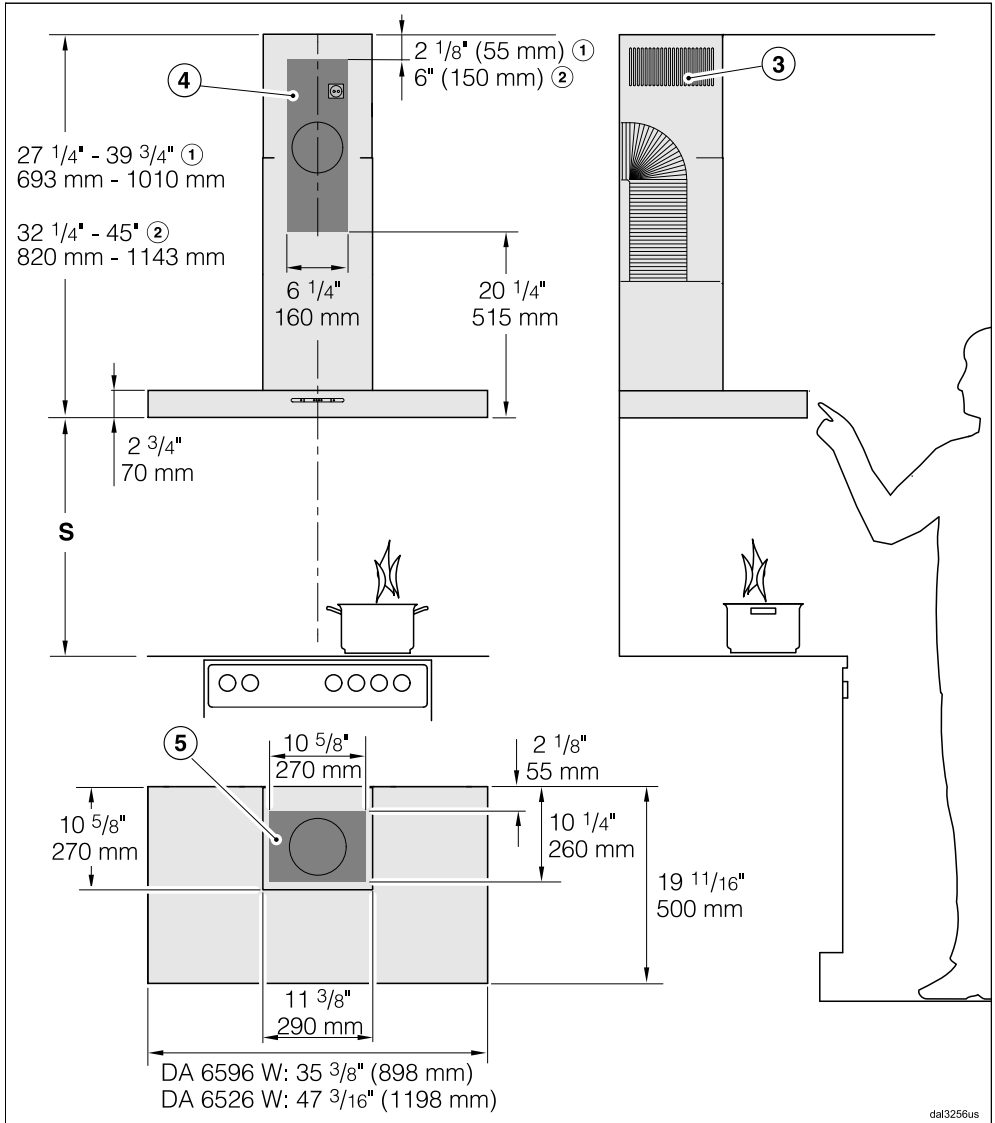

The drawing is not to scale.

- ① Extraction
- ② Recirculation (only DA 6596 W)
- ③ Air vent positioned at the top for recirculation

- ④⑤ Installation area (only ④ is required for recirculation ventilation hoods). Wall and ceiling area for exhaust duct opening and for wall socket installation. Only the wall socket installation is required for recirculation hoods.

Vent collar Ø 6" (150 mm)

## Distance between cooktop and ventilation hood (S)

Provided a larger distance is not given by the manufacturer of the cooktop, follow the minimum safety distances between a cooktop and the bottom of the hood.

Please also observe the information contained in the "IMPORTANT SAFETY INSTRUCTIONS" section.

Cooking appliance	Minimum distance S	
	Miele appliance	Non-Miele appliance
Electric Cooktops	24" (610 mm)	
Electric Barbeques and Fryers	26" (660 mm)	
Multiburner Gas Cooktops ≤ 43,000 BTU/hr (12.6 kW), no burner > 15,000 BTU/hr (4.5 kW).	26" (660 mm)	30" (760 mm)
Multiburner Gas Cooktops ≤ 73,800 BTU/hr (21.6 kW), no burner > 16,500 BTU/hr (4.8 kW)	30" (760 mm)	
Multiburner Gas Cooktops > 73,800 BTU/hr (21.6 kW), or one of the burners > 16,500 BTU/hr (4.8 kW)	Not possible	
Single Burner Gas Cooktops ≤ 20,500 BTU/hr (6 kW)	26" (660 mm)	30" (760 mm)
Single Burner Gas Cooktops > 20,500 BTU/hr (6 kW) ≤ 27,600 BTU/hr (8.1 kW)	30" (760 mm)	
Single Burner Gas Cooktops > 27,600 BTU/hr (8.1 kW)	Not possible	

# Installation

## Installation recommendations

- A distance of at least 26" (660 mm) is recommended above electric cooktops to provide more workspace and easier cooking under the hood.
- When selecting an installation height, always take the user height into consideration. Users should have ample space to work comfortably on the cooktop and reach the ventilation hood controls with ease.
- Please note that the greater the distance from the cooktop, the less effective the hood is at drawing in the cooking vapors.
- To achieve optimum vapor extraction, the hood must be centered over the cooktop, not to the side.
- The cooktop should be no wider than the hood. Preferably, it should be narrower for better extraction.
- The mounting area must be easily accessible. The ventilation hood should be easy to reach and disassemble in case a service call is necessary. This should be taken into consideration when planning the position of cabinetry, shelves, ceilings or decorative elements in the vicinity of the ventilation hood.

## Drilling diagram for wall mounting

- Please follow the directions given in the installation instructions supplied for drilling.

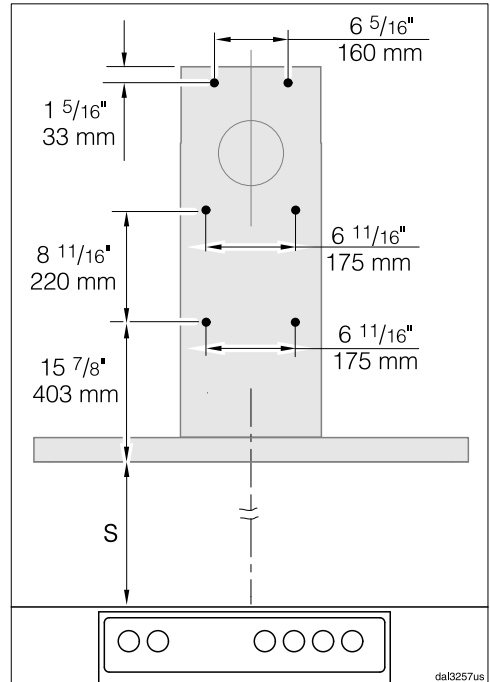

- When installing a custom back wall with pre-drilled holes, please refer to the drilling distances in the drawing above (screws  $\varnothing \frac{3}{16}''$  (5 mm)).



## Plywood backing

The majority of the weight of the installed ventilation system will be supported by the lower retaining plate. It must be firmly attached to the stud framing behind the drywall. If studs are not available in the required locations, a plywood backing (min. ½" (13 mm) thick) spanning at least two studs must be installed.

Failure to adequately support the weight as stated may result in the ventilation system falling off the wall, causing personal injury and property damage.

If plywood backing is not needed, proceed to the included "Installation diagram".

## To install a plywood backing

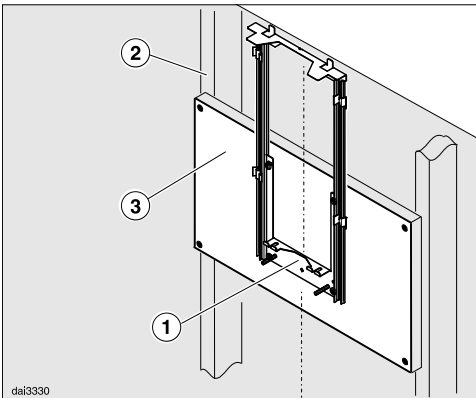

- Determine and mark the location of the retaining plate ① for the canopy as outlined on the "Installation diagram".

- Make a cutting line 3" (76 mm) above and 3" (76 mm) below the outline of the retaining plate.
- Find the studs ② to the left and right of the mounting location by tapping the wall or using a stud finder.
- Mark a vertical cutting line along the center of each stud.

**CAUTION:** When cutting or drilling into the wall or ceiling, do not damage electrical wiring and other hidden utilities.

- Remove the drywall between the cutting lines and replace it with plywood ③ of a matching thickness (min. ½" (13 mm) thick). Tape the joints and refinish the wall.
- Proceed to the enclosed "Installation diagram" to complete the installation.

# Installation

## Air venting

**WARNING:** Danger of toxic fumes. Gas cooking appliances release carbon monoxide that can be harmful or fatal if inhaled.

To reduce the risk of fire and to properly exhaust air, the exhaust gases extracted by the hood should be vented outside of the building only.

Do not vent exhaust air into spaces within walls or ceilings or in attics, crawl spaces or garages.

To reduce the risk of fire, only use metal ductwork.

Please read and follow the “IMPORTANT SAFETY INSTRUCTIONS” to reduce the risk of personal injury. Follow all local building codes when installing the hood.

Only use smooth pipes or flexible ducting made from approved non-flammable materials for ducting.

To achieve the most efficient air throughput with the lowest noise levels, please note the following:

- The diameter of the vent ducting must not be smaller than the cross-section of the vent collar (see “Appliance dimensions”). This applies in particular when using flat ducting.
- The ducting should be as short and straight as possible.
- Only use wide radius bends.
- The ducting must not be kinked or compressed.

- All connections must be strong and airtight.
- If the ducting has flaps, these must be opened whenever the ventilation hood is switched on.

Any constriction of the air throughput will reduce extraction performance and increase operating noise.

## Ventilation stack

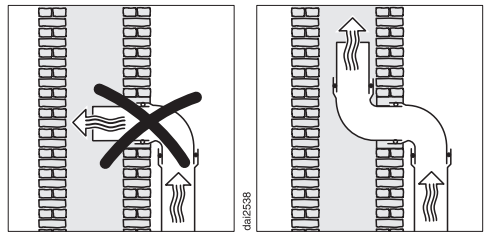

If the exhaust air is to be ducted into a flue, the ducting must be directed in the flow direction of the flue.

If the flue is used by several ventilation units, the cross-section of the flue must be large enough.

## Non-return flap

- Use a non-return flap in the vent system.

A non-return flap ensures that when the ventilation hood is not in operation, the duct is closed to prevent unwanted exchange of room air and outside air.

If the exhaust is ducted through an outside wall, a Miele wall vent or roof vent (available as an optional accessory) is recommended. Both of these have a built-in non-return flap.

If the on-site vent system does not have a non-return flap, you can purchase one as an optional accessory.

## Condensate

If the ducting is to run through cool rooms or ceiling space, for example, the significant variations in temperature between the different areas can cause condensate to form. Insulate the ducting to reduce temperature variations.

If the ducting is to be laid horizontally, it must be laid with a downwards sloping gradient of at least  $\frac{3}{8}$ " (1 cm) per meter. This is to ensure that condensate cannot drain back into the ventilation hood.

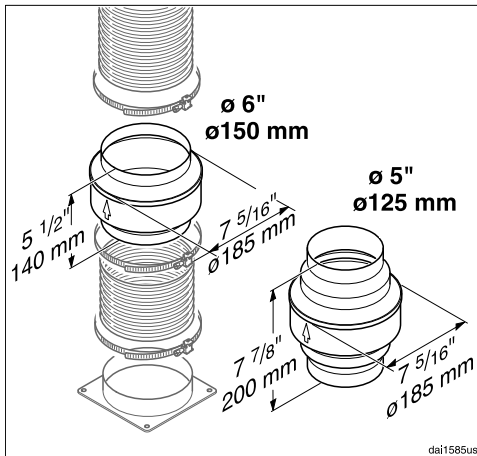

In addition to insulating the ducting, it is advisable to also install a condensate trap for collecting and evaporating any potential condensate.

Condensate traps for 5" (125 mm) or 6" (150 mm) diameter ducting are available as optional accessories.

When installing a condensate trap, ensure that it is positioned vertically and as closely as possible to the ventilation hood above the exhaust vent. The arrow on the casing indicates the direction of airflow.

Miele will not accept warranty claims for any functional defects or damage caused by inadequate ducting.

## Reducing Collar

(optional accessory)

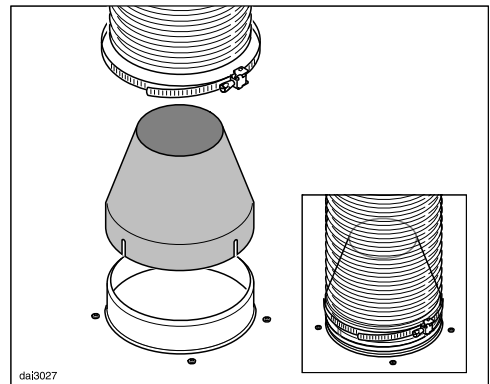

If you would like to reduce the environmental impact of your ventilation system by limiting the CFM output the Reducing Collar can be installed. It reduces the air flow to less than 400 CFM. Check local building codes for max. CFM requirements.

- Push the Reducing Collar on the exhaust port of the blower.
- Push the exhaust hose over it.
- Secure both with a hose clamp.

# Installation

## Electrical connection

**WARNING: TO REDUCE THE RISK OF FIRE, ELECTRIC SHOCK, OR INJURY TO PERSONS, OBSERVE THE FOLLOWING:**

All electrical work should be performed by a qualified electrician in strict accordance with national regulations (for USA: ANSI-NFPA 70) and local safety regulations.

Installation, repairs and other work by unqualified persons could be dangerous.

Ensure that power to the appliance is OFF while installation or repair work is performed.

Verify that the voltage, load and circuit rating information found on the data plate (see "Technical Service"), match the household electrical supply before installing the hood.

Use only with ventilation hood cord-connection kits that have been investigated and found acceptable for use with this model hood.

If there is any question concerning the electrical connection of this appliance to your power supply, please consult a licensed electrician or call Miele's Technical Service Department.

**WARNING: THIS APPLIANCE MUST BE GROUNDED**

## Grounding Instructions

**WARNING - Improper grounding can result in a risk of electric shock.**

This appliance must be grounded. In the event of an electrical short circuit, grounding reduces the risk of electric shock by providing a path of least resistance. This appliance is equipped with a cord having a grounding wire with a grounding plug.

If there is any doubt, have the electrical system of the house checked by a qualified electrician.

Do not use an extension cord. If the power supply cord is too short, have a qualified electrician install an outlet near the appliance.

- The plug must be plugged into an outlet that is properly installed and grounded.

**WARNING - Grounding instructions (Canada)**

The grounding-type attachment plug shall be connected to a grounding-type receptacle installed in accordance with CSA C22.1-12, Canadian Electrical Code, Part I.

## Installation of the Con@ctivity 2.0 stick

In order for you to be able to use the Con@ctivity 2.0 function, the cooktop must be equipped with a Con@ctivity 2.0 stick.

- See the relevant installation instructions of the Con@ctivity 2.0 stick.

## Activating the Con@ctivity 2.0 function



To use the Con@ctivity 2.0 function, the radio link between the cooktop and the ventilation hood must be activated.

Both appliances must be installed and operational.

Wireless connection must be activated on the ventilation hood and the cooktop at the same time. Activation on the ventilation hood is described below.

Activation on the cooktop is described in the relevant operating and installation instructions. Please refer to the operating instructions before starting. Activate the ventilation hood first, then the cooktop.

## Activating the ventilation hood

- The cooktop and ventilation hood must be turned off.
- Press and hold the delayed shutdown button **5**  **15** for approx. 10 seconds until the **1** indicator appears in the fan level display.
- Then, press the following buttons in order:
  - The **—** button
  - Followed by the **+** button
  - And then the lighting button .

The hood is in log on / log off mode.

If the wireless connection is activated, **2** and **3** will light up at the same time.

If there is no wireless connection, **2** and **3** will flash constantly (Con@ctivity 2.0 is already activated or a remote control is logged on).

- To activate Con@ctivity 2.0, press the “+” button.

The search for a wireless connection will start.

- As this is happening, activate the cooktop.

# Activating Con@ctivity 2.0

---

## Activating the cooktop

- **While** the ventilation hood is searching for a wireless connection, start activation on the cooktop. More information can be found in the operating instructions for the cooktop.
- When the cooktop registers that connection has been established, confirm activation on the ventilation hood with the delayed shut-down button **5**  **15**. All indicators will go out.
- Confirm activation on the cooktop.

The Con@ctivity 2.0 function is now ready for use.

If you do not confirm within 4 minutes, activation will be canceled.

You only need to carry out the activation procedure once. If the appliances are disconnected from the electricity supply, for example during a loss of power, they will still remain activated.

## Activation failed

If a wireless connection cannot be established despite activation of the Con@ctivity function on the ventilation hood and cooktop, the function must first be deactivated and then reactivated on both appliances.

## Deactivating Con@ctivity 2.0

- Deactivation on the ventilation hood is carried out in the same way as activation, by selecting — instead of +.
- To deactivate the burner, please refer to the corresponding operating instructions.

Please keep in mind that disabling the connection will also disable any remote control function being used. The remote control must then be reactivated.

## Contact in the event of a fault

In the event of a fault which you cannot remedy yourself, please contact your Miele dealer or Miele Customer Service.

You can book a Miele Service Call online at [www.miele.com/service](http://www.miele.com/service).

Contact information for Miele Customer Service can be found at the end of this document.

Please quote the model identifier and serial number of your appliance (SN) when contacting Miele Customer Service. Both pieces of information can be found on the data plate.

## Location of the data plate

The data plate is visible once you have removed the grease filters.

# Technical data

Fan motor	350 W
Cooktop lighting	3 x 3 W
Total connected load	359 W
Voltage, Frequency	120 V AC, 60 Hz
Fuse rating	15 A
Power cord length	2.5 ft (0.75 m)
Weight	
DA 6596 W	55 lbs (25 kg)
DA 6526 W	61.6 lbs (28 kg)

## Optional accessories for recirculation mode

DUW 20 conversion kit and DKF 12-900 charcoal filter



Contains  
FCC ID: 2ACUWEI8800  
IC: 5669C-EI8800

This device complies with Part 15 of the FCC Rules and with Industry Canada licence-exempt RSS standard(s). Operation is subject to the following two conditions: (1) this device may not cause harmful interference, and (2) this device must accept any interference received, including interference that may cause undesired operation.

eat3491







**Please have the model and serial number  
of your appliance available when  
contacting Customer Service.**

---

## **U.S.A.**

**Miele, Inc.**

### **National Headquarters**

9 Independence Way  
Princeton, NJ 08540  
[www.mieleusa.com](http://www.mieleusa.com)

### **Customer Support**

Phone: 888-99-MIELE (64353)  
[info@mieleusa.com](mailto:info@mieleusa.com)

### **International Headquarters**

Miele & Cie. KG  
Carl-Miele-Straße 29  
33332 Gütersloh  
Germany

## **Canada**

**Importer  
Miele Limited**

### **Headquarters and Miele Centre**

161 Four Valley Drive  
Vaughan, ON L4K 4V8  
[www.miele.ca](http://www.miele.ca)

### **Customer Care Centre**

Phone: 1-800-565-6435  
905-532-2272  
[customercare@miele.ca](mailto:customercare@miele.ca)

DA 6596 W, DA 6526 W

en-US

M.-Nr. 12 253 840 / 00