

SPR36UGMX

Range size	36"
Cooktop type	Gas
Main oven	Thermo-ventilated
EAN code	8017709316587











Aesthetic

Series	Professional	Controls color	Stainless steel
Color	Stainless steel	Silkscreen color	Black
Finishing	Satin	Handle	Robust knurled handle
Upstand	Yes	Handle color	Brushed stainless steel
Cooktop color	Black enamel	Logo	Assembled
Control panel finish	Stainless steel	Logo position	Fascia below the oven
Control knobs	Pro-style control knobs		

Programs / Functions

No. of cooking functions 8

Traditional cooking functions

 Static	 Fan-assisted	 True European convection
 Small grill	 Large grill	 Large grill + Fan
 Convection bottom	 Pizza	

Cleaning functions

 VaporClean

Other functions

 Defrost by time

Cooktop technical features

Cooking zones 6

Front-left
 Rear-left
 Front-center
 Rear-center
 Front-right
 Rear-right

Main Oven Technical Features



No. of lights	2	Removable inner door	Yes
Fan number	2	Total no. of door glasses	3
Volume	4.45 cu. ft.	Cooling system	Tangential
Cavity material	EverClean enamel	Bottom heating element - Power	1700 W
No. of shelves	5	Upper heating element - Power	1200 W
Shelves type	Metal racks	Grill power	1700 W
Light type	Halogen	Large grill - Power	2900 W
Light Power	40 W	Circular heating element - Power	2 x 1550 W
Time setting	Minute minder	Grill type	Electric
Removable door	Yes	Soft Close system	Yes
Full-glass inner door	Yes		

Main oven options

Minimum Temperature	150 °F	Maximum temperature	500 °F
---------------------	--------	---------------------	--------

Accessories included for main oven and cooktop

Oven grid with back-stop, tray support	2	Meat Probe	1
--	---	------------	---

Electrical Connection

Plug	(B) USA 120V	Voltage	208/240 V
Electrical connection rating	3800 W	Frequency	60 Hz
Current	16 A	Power cord length	47 1/4 "
Circuit breaker	20 A	Terminal block	3 pins

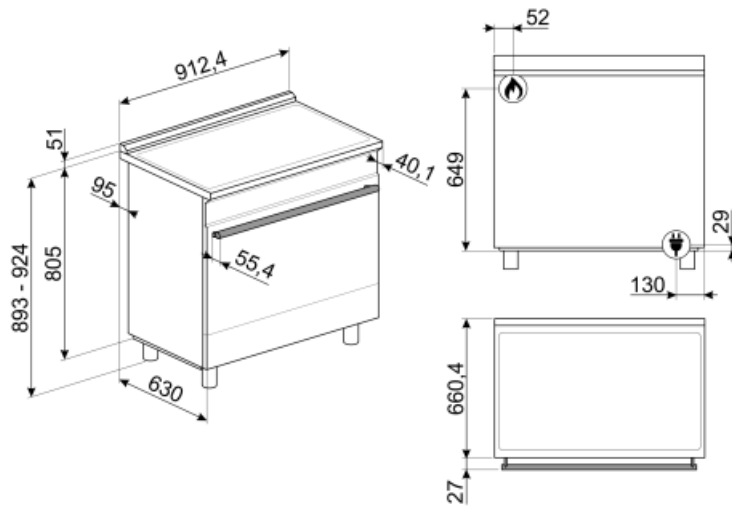

Not included accessories



SFLK1
Child lock



GRM
Gas hobs moka support





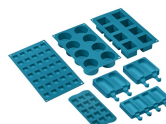















GT3T



SMOLD
Set of 7 silicone moulds for ice creams, ice lollies, pralines, ice cubes or to portion food. Usable from -60°C to +230°C

Symbols glossary (TT)

 <p>Air cooling system: to ensure a safe surface temperatures.</p>	 <p>Defrost by time: with this function the time of thawing of foods are determined automatically.</p>
 <p>Triple glazed doors: Number of glazed doors.</p>	 <p>Enamel interior: The enamel interior of all Smeg ovens have a special antacid lining which helps keep the interior clean by reducing the amount of cooking grease adhering to it.</p>
 <p>Circogas: In gas ovens the fan distributes the heat quickly and evenly throughout the oven cavity, avoiding flavour transfer when cooking a number of different dishes at the same time. In electric ovens this combination completes cooking more quickly of foods that are ready on the surface, but that require more cooking inside, without further browning.</p>	 <p>Fan with upper and lower elements: The elements combined with the fan aim to provide more uniform heat, a similar method to conventional cooking, so pre-heat is required. Most suitable for items requiring slow cooking methods.</p>
 <p>Upper and lower element only: a traditional cooking method best suited for single items located in the centre of the oven. the top pf the oven will always be hottest. Ideal for roast, fruit cakes, bread etc.</p>	 <p>Circulaire: The combination of the fan and circular element around it gives a hot air cooking method. This provides many benefits including no preheat if cook time is more than 20 minutes, no flavour transfer when cooking different foods at the same time, less energy, and shorter cook times. Good for all types of food.</p>
 <p>Grill element: Using of grill gives excellent results when cooking meat of medium and small portions, especially when combined with a rotisserie (where possible). Also ideal for cooking sausages and bacon.</p>	 <p>Half grill: For rapid cooking and browning of foods. Best results can be obtained by using the top shelf for small items, the lower shelves for larger ones, such as chops or sausages. For half grill heat is generated only at the centre of the element, so is ideal for smaller quantities.</p>
 <p>Fan with grill element: The fan reduces the fierce heat from the grill, providing an excellent method of grilling various foods, chops, steaks, sausages etc. giving even browning and heat distribution, without drying out the food. The top two levels recommended for use, and the lower part of the oven can be used to keep items warm at the same time, an excellent facility when cooking a grilled breakfast. Half grill (centre portion only) is ideal for small quantities of food.</p>	 <p>Pizza function: The simultaneous operation of three elements ensures an optimum cooking facility when used with the Smeg pizza stone.</p>
 <p>All glass inner door: All glass inner door, a single flat surface which is simple to keep clean.</p>	 <p>The inner door glass: can be removed with a few quick movements for cleaning.</p>
 <p>Side lights: Two opposing side lights increase visibility inside the oven.</p>	 <p>The oven cavity has 5 different cooking levels.</p>
 <p>Soft close: all models are equipped with advanced function of smooth closing of the door, which allows the device to close smoothly and quietly.</p>	 <p>Vapor Clean: a simple cleaning function using steam to loosen deposits in the oven cavity.</p>