



Sereno[®]



Kitchen Faucet S-2302-PD Installation Brief

Model Numbers

S-2302-PD Kitchen Faucet

Tools & Materials



Care and Cleaning

Clean finished area using mild soap or a non-abrasive cleaner and then quickly rinse with water. A non-abrasive wax may be used to preserve finish area. Using abrasive cleaners, solvents or acid cleaners will damage the finish and VOID the Symmons warranty.

Need Help?

Contact Symmons customer service at
Phone: (800) 796-6667
Email: gethelp@symmons.com
Monday - Friday 7:30 am - 6:00 pm EST

Please check Symmons website for technical help, the latest product information and warranty policy.
www.symmons.com/service

Quick Install Guide Sereno Kitchen Faucet, S-2302-PD

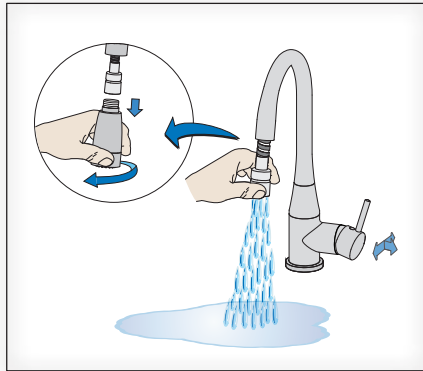

Step 5
Flush supply lines
and check for leaks

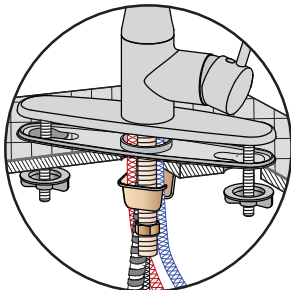

Optional deck plate:
Fasten deck plate and faucet to sink as shown above.

finished deck
front view
base
base o-ring

~ 13 -14 inches
(330 - 356 mm)

Step 3
Attach counterweight

Step 1
Attach faucet
centerbody

Step 4
Connect water
supply lines

Step 2
Connect
handspray hose

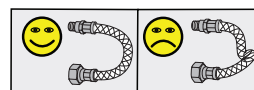

Dimensions Sereno Kitchen Faucet, S-2302-PD

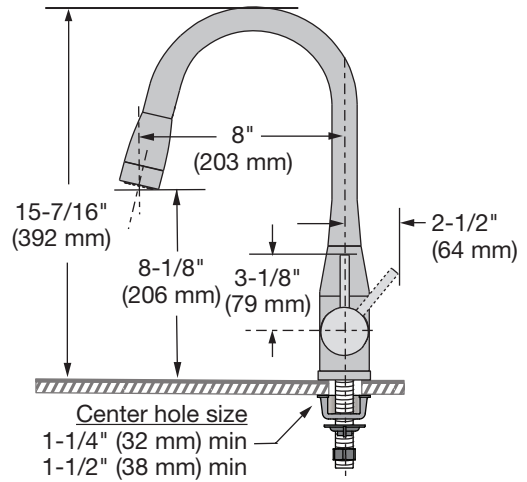
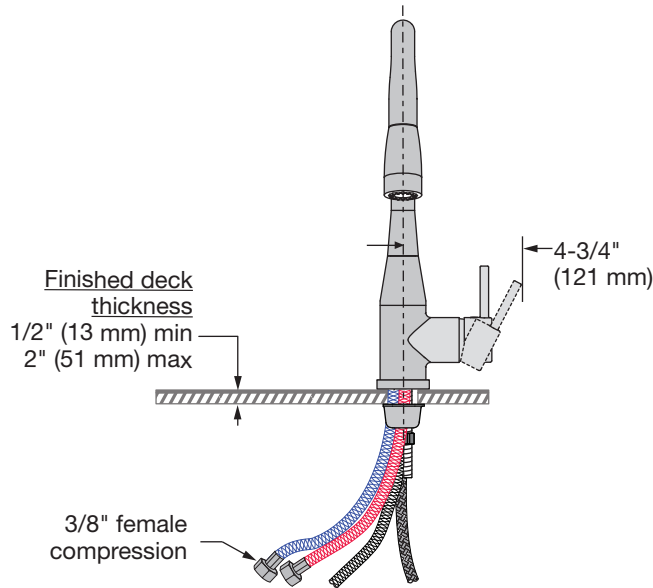

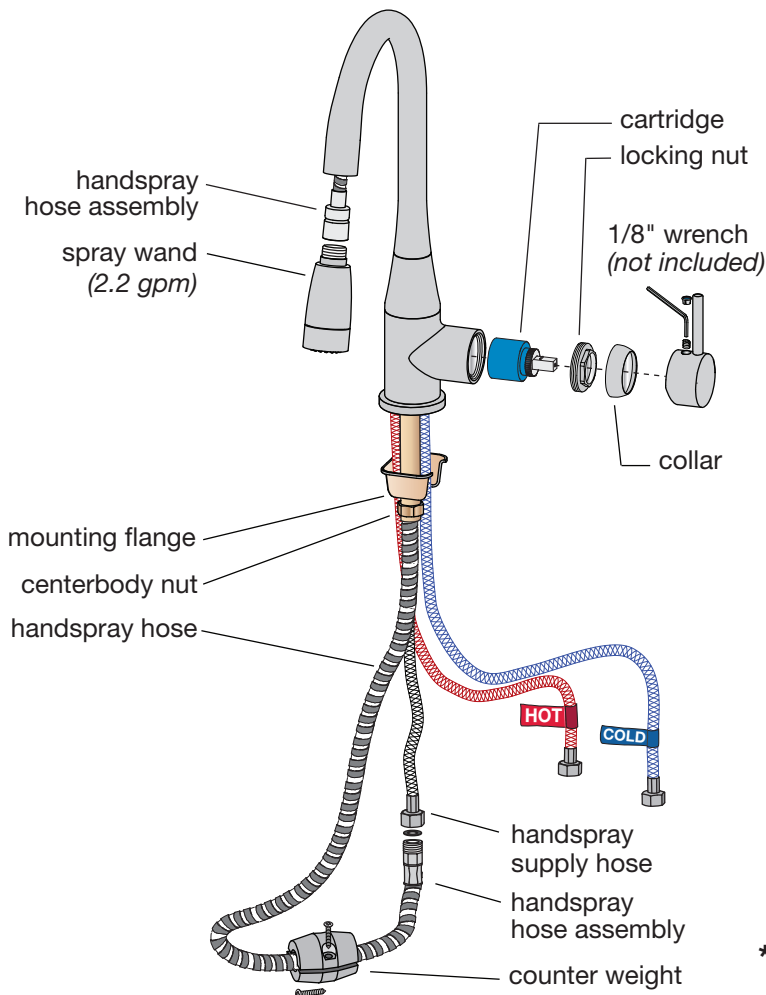

Note: Dimensions subject to change without notice
Braided supply hoses length approx. 21" (533 mm)

Parts Assembly Sereno Kitchen Faucet, S-2302-PD

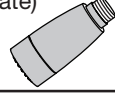
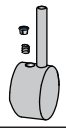

Replacement Parts

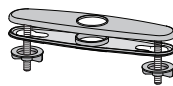
Part Number	Item	
KN-4	Valve cartridge	
RK-010 RK-010-1.5	Spray wand (flow rate) (2.2 gpm) (1.5 gpm)	
RK-009*	Handle kit	plug screw handle 
RK-011	Counter weight	
RK-008	Mounting hardware kit	base o-ring mounting flange centerbody nut 
RK-012*	Optional 8" Deck plate kit	deck plate gasket flange nuts 
RK-021*	Pull down hose	

Ordering replacement parts:

Symmons customer service:
Phone: (800) 796-6667, M-F 7:30 am - 6:00 pm EST
Symmons distributors: www.symmons.com

* Note: For faucets with an optional decorative finish, add appropriate suffix code letters to part numbers marked with an asterisk (*) when ordering.