







Location:



S-3601  
Shower System  
Specification Submittal

<p><b>Feature Highlights</b></p> <ul style="list-style-type: none"> <li>• Secondary integral volume control</li> <li>• Metal lever handle</li> <li>• Adjustable stop screw to limit handle turn</li> <li>• 1 mode showerhead</li> <li>• 2.5 gpm (9.5 L/min) standard flow restrictor</li> <li>• Tub spout not included</li> <li>• Components shall be metal and nonmetallic construction, plated in standard polished chrome finish</li> </ul>	<p><b>Options/Modifications cont.</b></p> <ul style="list-style-type: none"> <li><input type="checkbox"/> <b>-BBZ</b> <i>Brushed Bronze finish (available 2018)</i></li> <li><input type="checkbox"/> <b>-MB</b> <i>Matte Black finish (available 2018)</i></li> <li><input type="checkbox"/> <b>-STN</b> <i>Satin Nickel finish</i></li> </ul> <p><b>Note:</b> Append appropriate -suffix to model number.</p>
<p><b>Model Numbers</b></p> <ul style="list-style-type: none"> <li><input type="checkbox"/> <b>S-3601</b> Shower System with Symmons Temptrol® 4-port pressure balancing mixing valve</li> <li><input type="checkbox"/> <b>S-46-1-BODY</b> Symmons Temptrol 4-port pressure balancing mixing valve</li> <li><input type="checkbox"/> <b>S-46-1X-BODY</b> Symmons Temptrol 4-port pressure balancing mixing valve with integral service stops</li> </ul>	<p><b>Compliance</b></p> <p>- ASME A112.18.1/CSA B125.1</p> 
<p><b>Options/Modifications</b></p> <ul style="list-style-type: none"> <li><input type="checkbox"/> <b>-1.5</b>  <i>1.5 gpm (5.7 L/min) flow restrictor</i></li> <li><input type="checkbox"/> <b>-2.0</b> <i>2.0 gpm (7.6 L/min) flow restrictor</i></li> <li><input type="checkbox"/> <b>-IPS</b> <i>1/2" female IPS connections</i></li> <li><input type="checkbox"/> <b>-L/HD</b> <i>Less showerhead</i></li> <li><input type="checkbox"/> <b>-REB</b> <i>Rebuild trim kit, includes TA-10 and TA-4</i></li> <li><input type="checkbox"/> <b>-REV</b> <i>Reverse coring, hot on right, cold on left, for back to back installations</i></li> <li><input type="checkbox"/> <b>-SH1</b>  <i>Alternative 352SH Dia showerhead</i></li> <li><input type="checkbox"/> <b>-SH2</b>  <i>Alternative 352SH-3, 3 mode showerhead (Chrome and Satin Nickel finish only)</i></li> <li><input type="checkbox"/> <b>-SH4</b>  <i>Alternative 361SH square showerhead</i></li> <li><input type="checkbox"/> <b>-TRM</b> <i>Trim only, valve must be ordered separately</i></li> <li><input type="checkbox"/> <b>-VP</b> <i>Vandal resistant escutcheon screws in place of standard screws</i></li> <li><input type="checkbox"/> <b>-X</b> <i>Integral service stops - allows water shutoff at valve for service</i></li> <li><input type="checkbox"/> <b>-X-CHKS</b> <i>Integral check stops - for use in installations where a positive shut-off device is used downstream of mixing valve</i></li> </ul>	<p><b>Warranty</b></p> <p><b>Limited Lifetime</b> - to the original end purchaser in consumer/residential installations.  <b>5 Years</b> - for industrial/commercial installations.  Refer to <a href="http://www.symmons.com/warranty">www.symmons.com/warranty</a> for complete warranty information.</p>

## Dimensions

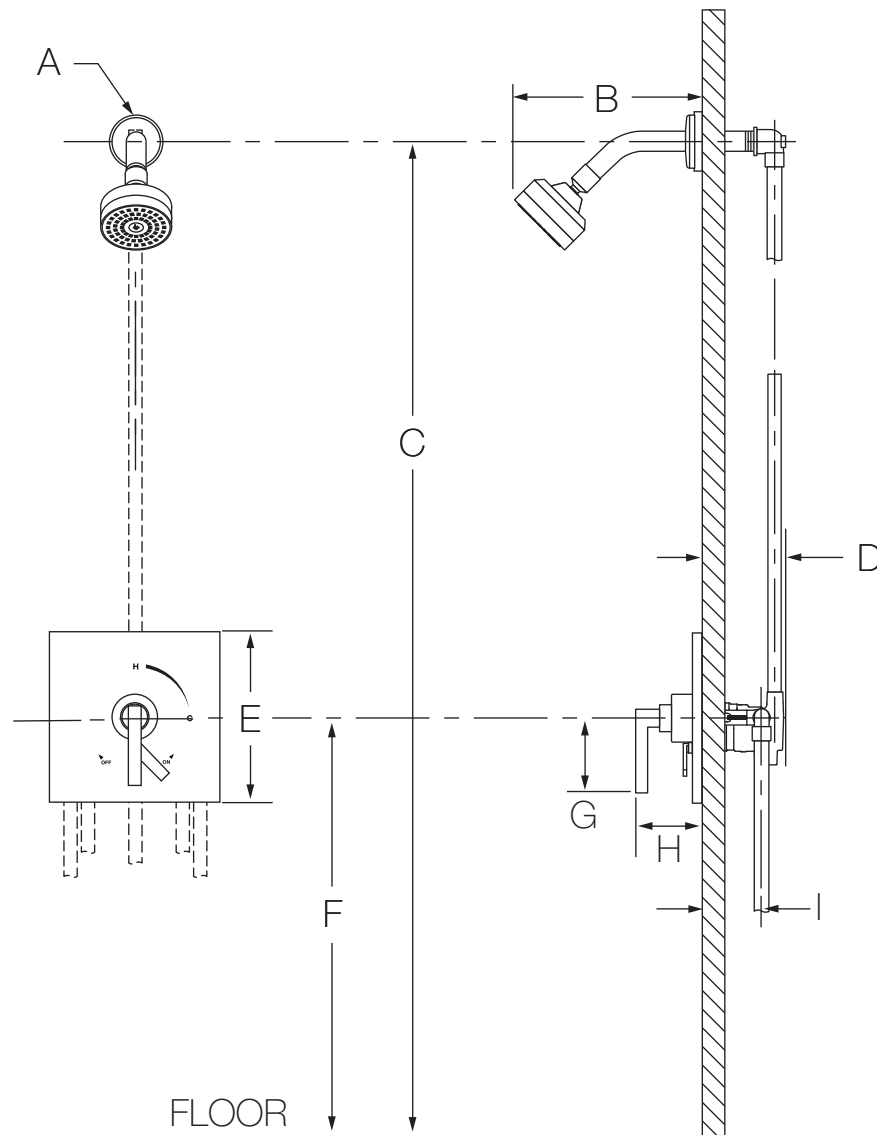

Measurements	
A	Ø 2-1/2", 64 mm
B	6", 152 mm
C	Ref. 77", 1956 mm
D	3-1/2", 89 mm
E	Sq. 7-1/2", 191 mm
F	Ref. 42", 1067 mm
G	3-1/8", 79 mm
H	3-1/2", 89 mm
I	Rough-in 2-3/8" ± 1/2", 60 mm ± 13 mm
J	6-3/4", 171 mm
K	6-3/4", 171 mm
L	5-5/8", 143 mm

**-SH1**

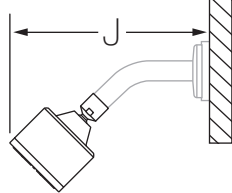

**-SH2**

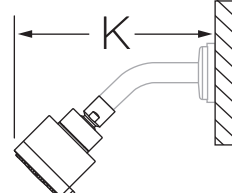

**-SH4**

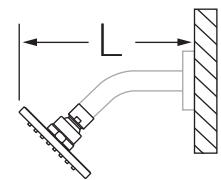
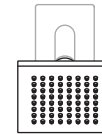

### Notes:

- 1) Plaster shield (p/n T-176) for dry wall, plaster or other type walls 1/2" or greater.
- 2) Do not install positive shut-off device/devices that do not allow the valve to flow at least 1.5 gpm to valve outlets.
- 3) All dimensions measured from nominal rough-in (see I as reference).
- 4) Dimensions subject to change without notice.