

**Model Number: CWEH6-K48**

Special Notes: LED GU10 lighting. This model is not available with heat lamps. Shown with optional duct cover (sold separately). Optional duct covers are available in standard and custom sizes.

<b>WIDTH:</b>	48"
<b>DEPTH:</b>	19 1/2"
<b>HEIGHT:</b>	6"
<b>CFM:</b>	250
<b>SONES:</b>	7.4
<b>AMPS:</b>	3.5
<b># LIGHTS:</b>	3

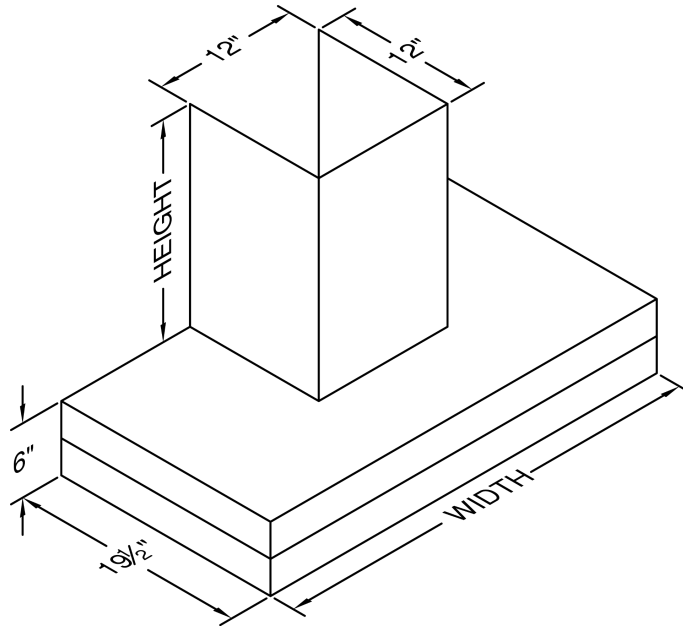

The VP521 transition is available for top vent applications at an additional charge.

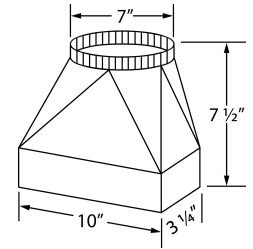

**CONNECTION DIAGRAM**

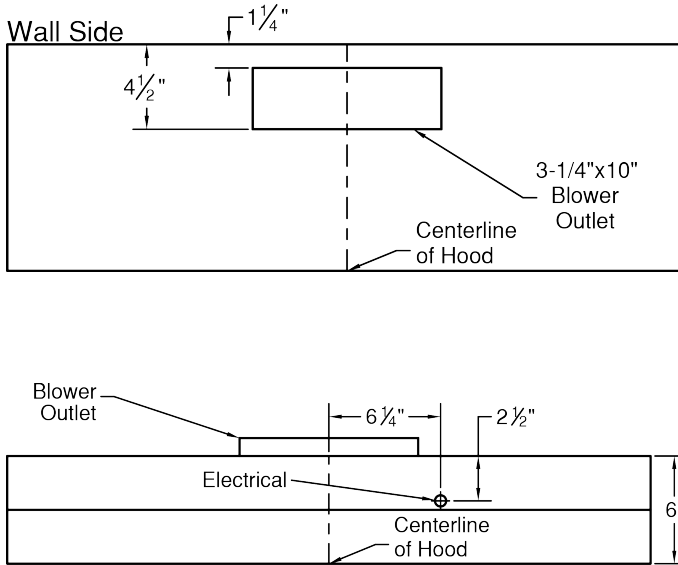

**REC. MOUNTING HEIGHT\***

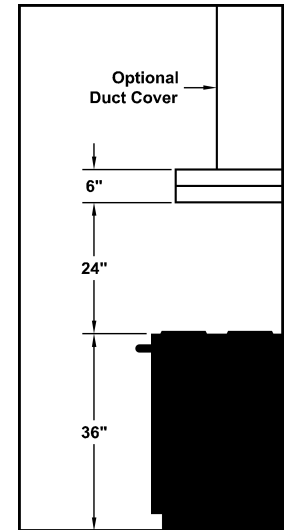

\* Exceeding recommended mounting height may compromise performance.

**ELECTRICAL/MECHANICAL SPECIFICATIONS FOR BLOWER UNIT**

MODEL	VOLTS	AMPS+	HZ	RPM	CFM SP@0.0"	EQUIV CFM\$	CFM SP@0.1"	CFM SP@0.2"	CFM SP@0.3"	MIN. ROUND DUCT SIZE	SONES#
K250 (Top Vent)	115	3.5	60	1550	250	375	223	220	190	7" (38 sq. in.)	7.4

+ This model is equipped with LED GU10 lighting: (2 lights: 30" - 41", 3 lights: 42" - 48").

\$ Because the Power Lung#8482; blower uses centrifugal filtration rather than conventional baffle or mesh filters, the Power Lung#8482; blower can handle cooking equipment with higher cubic feet per minute (CFM) requirements and can deliver equivalent CFM much more efficiently than other filtration systems. When comparing the Power Lung#8482; with other blower units made by other manufacturers, use the "Equivalent CFM".

# Ratings in accordance with the Standard Test Code by the Energy Systems Laboratory of the Texas Engineering Experiment Station.