

M Collection metro series

Wall-mount vanity

10" height – 18" depth



Furniture

Wall-mount vanity MM 1810 WM – 1 drawer – 18" length

17 7/8" depth x 17 3/4" length x 10" height – 454 x 451 x 254 mm

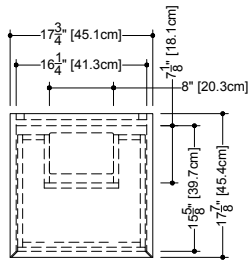

plan view

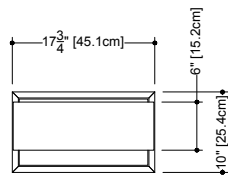

front view

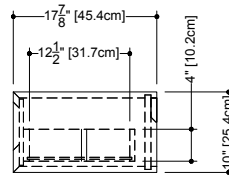

side view

finishes and colors

oak

natural
wenge
white
black
stone harbour grey
coffee bean
smoked

walnut

natural
natural no calico
chocolate

premium wood

eucalyptus
mozambique

matte lacquer*

white
stone harbour grey
black

high gloss lacquer**

white

- 45 degree bevel cuts precluding the need for drawer hardware

- All natural wood veneer

- AWI rated level 5 marine grade finish for moisture resistance and durability (industry's highest finishing class)

- Finished vanity interiors in addition to front and sides

- Solid maple dovetailed drawer

- Slow closing ball bearing glides

- Vanity top comes fully finished. Can be pre-cut at factory, upon request, if ordered with a vcs/vovs sink.

Special wall preparation recommendations:

the distance between studs should not exceed 16". Each stud should be reinforced vertically by 2" x 3" wooden studs and horizontally with 2" x 6" wooden studs at a height of 30" all along the width of the vanity.

* ATTENTION: Vessel sink not recommended with this finish

** ATTENTION: High-Gloss finish on sides and drawer facade only. Bottom and interior in white mat. This finish should only be ordered with an integrated countertop (vessel sink not recommended)

WETSTYLE cannot be held responsible for any technical errors and reserves the right to make revisions without notice.

Approximate measurement.
The manufacturer accepts 1/4" (6.35mm) variance.

Drawers configuration



Horseshoe

www.WETSTYLE.COM - Montreal - Canada
Tel. 1 888.536.9001 - service@wetstyle.com



Compatible Integrated Countertop for MM 1810 WM vanity
 (countertop sold separately)

Cube Collection Lavatories 18" depth x 18" length x 2" height — 457 x 457 x 51 mm

VCMS 18

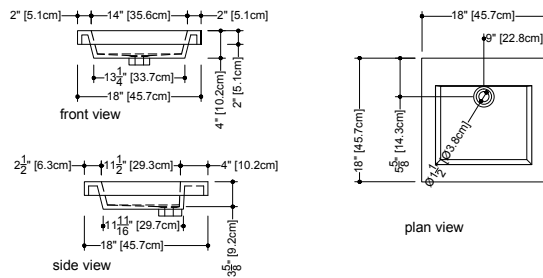

Also compatible with the following WETSTYLE vessel sink models
 (only if combined with a wall mounted faucet):

VC815A, VOV815A

WETSTYLE cannot be held responsible for any technical errors and reserves the right to make revisions without notice.

Approximate measurement.
 The manufacturer accepts 1/4" (6.35mm) variance.

www.WETSTYLE.COM - Montreal - Canada
 Tel. 1 888.536.9001 - service@wetstyle.com



M Collection metro series

Wall-mount vanity

10" height – 18" depth



Furniture

Wall-mount vanity MM 2010 WM – 1 drawer – 20" length

17 7/8" depth x 19 3/4" length x 10" height – 454 x 502 x 254 mm

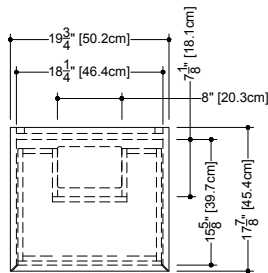

plan view

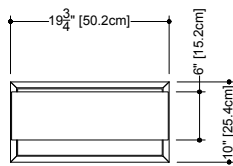

front view

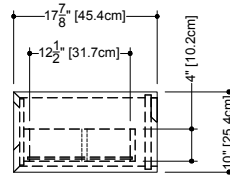

side view

finishes and colors

oak

natural
wenge
white
black
stone harbour grey
coffee bean
smoked

walnut

natural
natural no calico
chocolate

premium wood

eucalyptus
mozambique

matte lacquer*

white
stone harbour grey
black

high gloss lacquer**

white

- 45 degree bevel cuts precluding the need for drawer hardware

- All natural wood veneer

- AWI rated level 5 marine grade finish for moisture resistance and durability (industry's highest finishing class)

- Finished vanity interiors in addition to front and sides

- Solid maple dovetailed drawer

- Slow closing ball bearing glides

- Vanity top comes fully finished. Can be pre-cut at factory, upon request, if ordered with a vcs/vovs sink.

Special wall preparation recommendations:

the distance between studs should not exceed 16". Each stud should be reinforced vertically by 2" x 3" wooden studs and horizontally with 2" x 6" wooden studs at a height of 30" all along the width of the vanity.

* ATTENTION: Vessel sink not recommended with this finish

** ATTENTION: High-Gloss finish on sides and drawer facade only. Bottom and interior in white mat. This finish should only be ordered with an integrated countertop (vessel sink not recommended)

WETSTYLE cannot be held responsible for any technical errors and reserves the right to make revisions without notice.

Approximate measurement.
The manufacturer accepts 1/4" (6.35mm) variance.

Drawers configuration



Horseshoe

www.WETSTYLE.COM - Montreal - Canada
Tel. 1 888.536.9001 - service@wetstyle.com



Compatible Integrated Countertop for MM 2010 WM vanity
 (countertop sold separately)

Cube Collection Lavatories 18" depth x 20" length x 2" height — 457 x 508 x 51 mm

VCMS 20

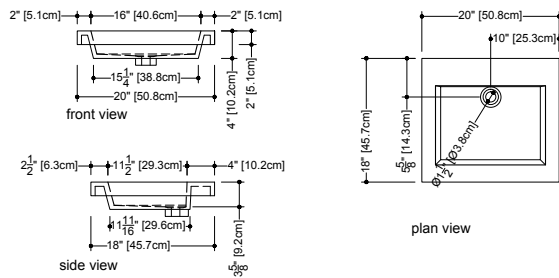

Also compatible with the following WETSTYLE vessel sink models

(only if combined with a wall mounted faucet):

VC815A, VOV815A

WETSTYLE cannot be held responsible for any technical errors and reserves the right to make revisions without notice.

Approximate measurement.
 The manufacturer accepts 1/4" (6.35mm) variance.

www.WETSTYLE.COM - Montreal - Canada
 Tel. 1 888.536.9001 - service@wetstyle.com



M Collection metro series

Wall-mount vanity

10" height – 18" depth



Furniture

Wall-mount vanity MM 2410 WM – 1 drawer – 24" length

17 7/8" depth x 23 3/4" length x 10" height – 454 x 603 x 254 mm

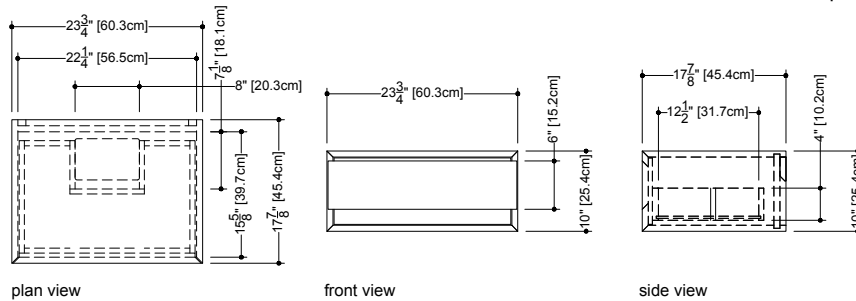

plan view

front view

side view

finishes and colors

oak

natural
wenge
white
black
stone harbour grey
coffee bean
smoked

walnut

natural
natural no calico
chocolate

premium wood

eucalyptus
mozambique

matte lacquer*

white
stone harbour grey
black

high gloss lacquer**

white

- 45 degree bevel cuts precluding the need for drawer hardware
- All natural wood veneer
- AWI rated level 5 marine grade finish for moisture resistance and durability (industry's highest finishing class)
- Finished vanity interiors in addition to front and sides
- Solid maple dovetailed drawer
- Slow closing ball bearing glides
- Vanity top comes fully finished. Can be pre-cut at factory, upon request, if ordered with a vcs/vovs sink.
- Special wall preparation recommendations:** the distance between studs should not exceed 16". Each stud should be reinforced vertically by 2" x 3" wooden studs and horizontally with 2" x 6" wooden studs at a height of 30" all along the width of the vanity.

* ATTENTION: Vessel sink not recommended with this finish

** ATTENTION: High-Gloss finish on sides and drawer facade only. Bottom and interior in white mat. This finish should only be ordered with an integrated countertop (vessel sink not recommended)

WETSTYLE cannot be held responsible for any technical errors and reserves the right to make revisions without notice.

Approximate measurement.
The manufacturer accepts 1/4" (6.35mm) variance.

Drawers configuration



Horseshoe

www.WETSTYLE.COM - Montreal - Canada
Tel. 1 888.536.9001 - service@wetstyle.com



Compatible Integrated Countertop for MM 2410 WM vanity

(countertop sold separately)

Cube Collection Lavatories 18" depth x 24" length x 2" height — 457 x 610 x 51 mm

VCMS 24

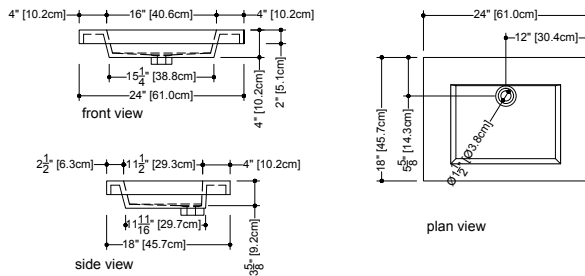

Also compatible with the following WETSTYLE vessel sink models

(only if combined with a wall mounted faucet):

VBE821A, VC815A, VC821A, VOV815A, VOV821A, VCR821A, VTP821A

WETSTYLE cannot be held responsible for any technical errors and reserves the right to make revisions without notice.

Approximate measurement.
The manufacturer accepts 1/4" (6.35mm) variance.

www.WETSTYLE.COM - Montreal - Canada
Tel. 1 888.536.9001 - service@wetstyle.com



M Collection metro series

Wall-mount vanity

10" height – 18" depth



Furniture

Wall-mount vanity MM 3010 WM – 1 drawer – 30" length

17 7/8" depth x 29 3/4" length x 10" height – 454 x 756 x 254 mm

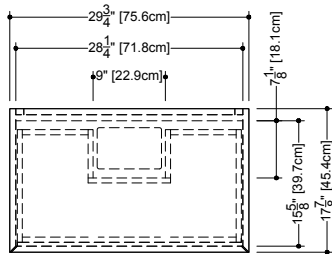

plan view

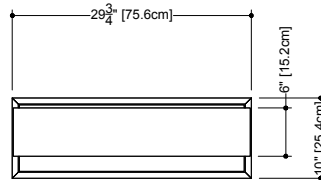

front view

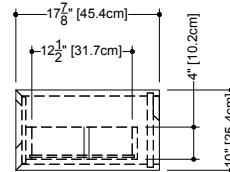

side view

finishes and colors

oak

natural
wenge
white
black
stone harbour grey
coffee bean
smoked

walnut

natural
natural no calico
chocolate

premium wood

eucalyptus
mozambique

matte lacquer*

white
stone harbour grey
black

high gloss lacquer**

white

- 45 degree bevel cuts precluding the need for drawer hardware

- All natural wood veneer

- AWI rated level 5 marine grade finish for moisture resistance and durability (industry's highest finishing class)

- Finished vanity interiors in addition to front and sides

- Solid maple dovetailed drawer

- Slow closing ball bearing glides

- Vanity top comes fully finished. Can be pre-cut at factory, upon request, if ordered with a vcs/vovs sink.

Special wall preparation recommendations:

the distance between studs should not exceed 16". Each stud should be reinforced vertically by 2" x 3" wooden studs and horizontally with 2" x 6" wooden studs at a height of 30" all along the width of the vanity.

* ATTENTION: Vessel sink not recommended with this finish

** ATTENTION: High-Gloss finish on sides and drawer facade only. Bottom and interior in white mat. This finish should only be ordered with an integrated countertop (vessel sink not recommended)

Drawers configuration



Horseshoe

WETSTYLE cannot be held responsible for any technical errors and reserves the right to make revisions without notice.

Approximate measurement.
The manufacturer accepts 1/4" (6.35mm) variance.

www.WETSTYLE.COM - Montreal - Canada
Tel. 1 888.536.9001 - service@wetstyle.com



Compatible Integrated Countertop for MM 3010 WM vanity
 (countertop sold separately)

Cube Collection Lavatories 18" depth x 30" length x 2" height — 457 x 762 x 51 mm

VCMS 30

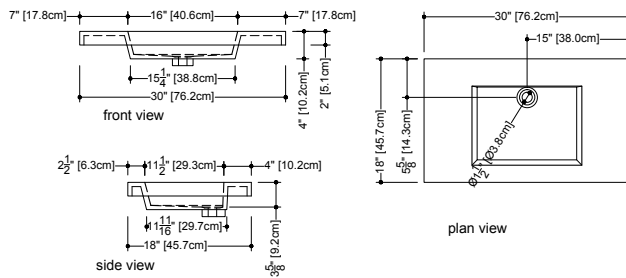

Also compatible with the following WETSTYLE vessel sink models

(only if combined with a wall mounted faucet):

VBE821A, VC815A, VC821A, VOV815A, VOV821A, VCR821A, VTP821A

WETSTYLE cannot be held responsible for any technical errors and reserves the right to make revisions without notice.

Approximate measurement.
 The manufacturer accepts 1/4" (6.35mm) variance.

www.WETSTYLE.COM - Montreal - Canada
 Tel. 1 888.536.9001 - service@wetstyle.com



M Collection metro series

Wall-mount vanity

10" height – 18" depth



Furniture

Wall-mount vanity MM 3610 WM – 1 drawer – 36" length

17 7/8" depth x 35 3/4" length x 10" height – 454 x 908 x 254 mm

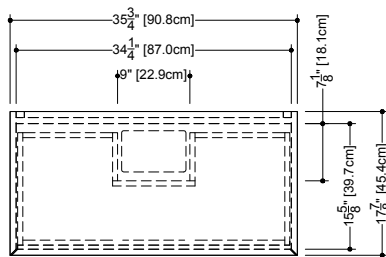

plan view

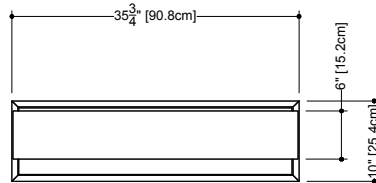

front view

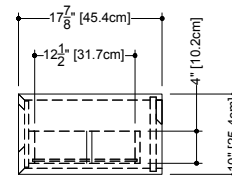

side view

finishes and colors

oak

natural
wenge
white
black
stone harbour grey
coffee bean
smoked

walnut

natural
natural no calico
chocolate

premium wood

eucalyptus
mozambique

matte lacquer*

white
stone harbour grey
black

high gloss lacquer**

white

- 45 degree bevel cuts precluding the need for drawer hardware

- All natural wood veneer

- AWI rated level 5 marine grade finish for moisture resistance and durability (industry's highest finishing class)

- Finished vanity interiors in addition to front and sides

- Solid maple dovetailed drawer

- Slow closing ball bearing glides

- Vanity top comes fully finished. Can be pre-cut at factory, upon request, if ordered with a vcs/vovs sink.

Special wall preparation recommendations:

the distance between studs should not exceed 16". Each stud should be reinforced vertically by 2"x 3" wooden studs and horizontally with 2"x 6" wooden studs at a height of 30" all along the width of the vanity.

* ATTENTION: Vessel sink not recommended with this finish

** ATTENTION: High-Gloss finish on sides and drawer facade only. Bottom and interior in white mat. This finish should only be ordered with an integrated countertop (vessel sink not recommended)

Drawers configuration



Horseshoe

WETSTYLE cannot be held responsible for any technical errors and reserves the right to make revisions without notice.

Approximate measurement.
The manufacturer accepts 1/4" (6.35mm) variance.

www.WETSTYLE.COM - Montreal - Canada
Tel. 1 888.536.9001 - service@wetstyle.com



Compatible Integrated Countertop for MM 3610 WM vanity
 (countertop sold separately)

Cube Collection Lavatories 18" depth x 36" length x 2" height — 457 x 914 x 51 mm

VCMS 36

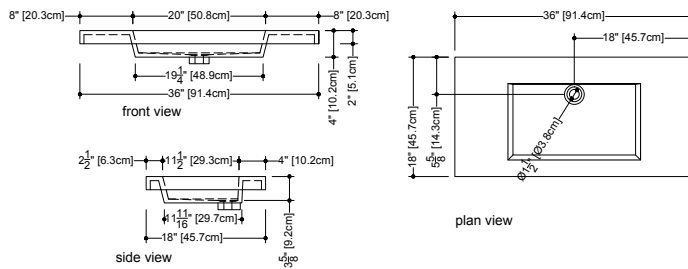

Also compatible with the following WETSTYLE vessel sink models

(only if combined with a wall mounted faucet):

VBE821A, VC815A, VC821A, VOV815A, VOV821A, VCR821A, VTP821A

WETSTYLE cannot be held responsible for any technical errors and reserves the right to make revisions without notice.

Approximate measurement.
 The manufacturer accepts 1/4" (6.35mm) variance.

www.WETSTYLE.COM - Montreal - Canada
 Tel. 1 888.536.9001 - service@wetstyle.com



M Collection metro series

Wall-mount vanity

10" height – 18" depth



Furniture

Wall-mount vanity MM 4210 WM – 1 drawer – 42" length

17 7/8" depth x 41 7/8" length x 18" height – 454 x 1064 x 457 mm

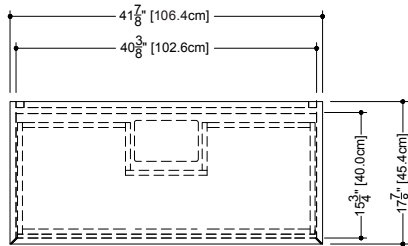

plan view

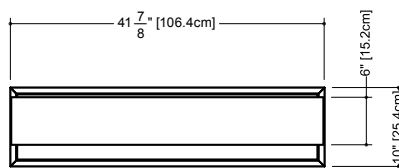

front view

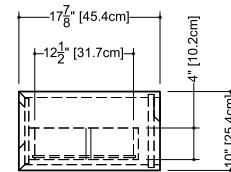

side view

finishes and colors

oak

natural
wenge
white
black
stone harbour grey
coffee bean
smoked

walnut

natural
natural no calico
chocolate

premium wood

eucalyptus
mozambique

matte lacquer*

white
stone harbour grey
black

high gloss lacquer**

white

- 45 degree bevel cuts precluding the need for drawer hardware
- All natural wood veneer
- AWI rated level 5 marine grade finish for moisture resistance and durability (industry's highest finishing class)
- Finished vanity interiors in addition to front and sides
- Solid maple dovetailed drawer
- Slow closing ball bearing glides
- Vanity top comes fully finished. Can be pre-cut at factory, upon request, if ordered with a vcs/vovs sink.
- Special wall preparation recommendations:**
the distance between studs should not exceed 16". Each stud should be reinforced vertically by 2" x 3" wooden studs and horizontally with 2" x 6" wooden studs at a height of 30" all along the width of the vanity.

* ATTENTION: Vessel sink not recommended with this finish

** ATTENTION: High-Gloss finish on sides and drawer facade only. Bottom and interior in white mat. This finish should only be ordered with an integrated countertop (vessel sink not recommended)

WETSTYLE cannot be held responsible for any technical errors and reserves the right to make revisions without notice.

Approximate measurement.
The manufacturer accepts 1/4" (6.35mm) variance.

Drawers configuration



Horseshoe

www.WETSTYLE.COM - Montreal - Canada
Tel. 1 888.536.9001 - service@wetstyle.com



Compatible Integrated Countertop for MM 4210 WM vanity

(countertop sold separately)

Cube Collection Lavatories 18" depth x 42" length x 2" height — 457 x 1067 x 51 mm

VCMS 42

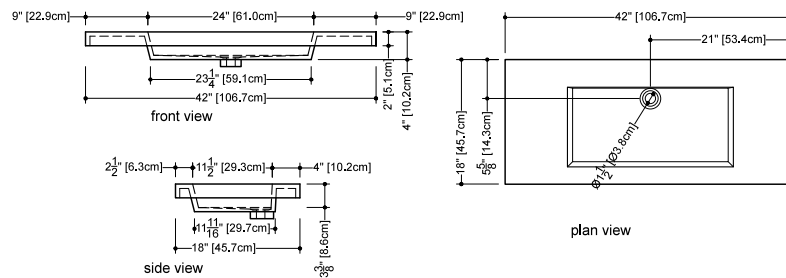

Also compatible with the following WETSTYLE vessel sink models

(only if combined with a wall mounted faucet):

VCR821A, VTP821A, VC815A, VC821A, VOV815A, VOV821A

WETSTYLE cannot be held responsible for any technical errors and reserves the right to make revisions without notice.

Approximate measurement.
The manufacturer accepts 1/4" (6.35mm) variance.

www.WETSTYLE.COM - Montreal - Canada
Tel. 1 888.536.9001 - service@wetstyle.com

