

**Application**

The Zurn Wilkins Model ZW206 Solenoid Operated Control Valve is designed to be either fully open or fully closed in response to an electrical signal to the solenoid pilot assembly. This valve is equipped with a 3-way electrical solenoid-operated pilot that can be plumbed to be normally closed (energize to open) or normally open (energize to close) providing main valve on/off capabilities.

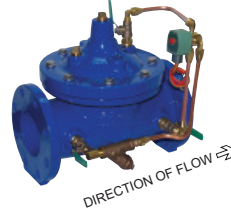

**Standards Compliance:**

- ANSI/AWWA C530
- Meets the requirements of NSF/ANSI 61\*  
\*(0.25% MAX. WEIGHTED AVERAGE LEAD CONTENT)

**Materials**

Main Valve Body	Ductile Iron ASTM A536
Main Valve Bonnet	Ductile Iron ASTM A536
Disc Guide	Stainless Steel
Seat	Stainless Steel
Disc	Buna-N Rubber
Diaphragm	Nylon Reinforced Buna-N
Stem	Stainless Steel
Spring	Stainless Steel
Coating	FDA Approved Fusion Epoxy

**Pilot System Specifications**

<b>Rubber Parts:</b>	Buna-N Rubber Synthetic Rubber
<b>Solenoid Control Body:</b>	Brass ASTM B283
<b>Enclosure:</b>	NEMA Type 1, 2, 3, 3S, 4, 4X general purpose watertight
<b>Voltages:</b>	110, 220-50Hz AC 24, 120, 240, 480-60Hz AC 6, 12, 24, 120, 240-DC others available

<b>Max. operating pressure differential:</b>	200 psi
<b>Coil:</b>	Insulation molded Class F
Watts AC	6
AC Volt Amps Inrush	30
AC Volt Amps Holding	16
Watts DC	10.6

**Schematic Diagram**

Item	Description of Standard Features
1	Main Valve
2	850XL Isolation Valve
3	SXL "Wye" Type Strainer
4	PV-SOL3 3-Way Solenoid Control

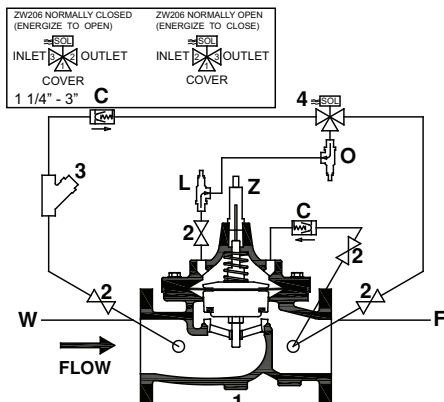

BODY CONFIGURATIONS		GLOBE STYLE BODY		ANGLE STYLE BODY
END CONNECTION	PRESSURE RATING	FULL PORT	REDUCED PORT	
Threaded	400 psi max.	1 1/4"-3"	n/a	1 1/4"-3"
Flanged	ANSI Class 150, 250 psi max.	1 1/2"-16"	3"-10"	1 1/2"-10"
	ANSI Class 300, 400 psi max.			
Grooved	300 psi max.	1 1/2"-10"	n/a	1 1/2"-10"
MINIMUM INLET PRESSURE 10 PSI				

Temperature Rating:  Water 33°F to 140°F

**Standard Features**

- Blue Epoxy Coated, FDA Approved
- Pilot Assembly
  - SXL "Wye" Type Strainer
  - 850XL Isolation Valves
  - 3-Way Accelerator Pilot (sizes 4" - 10")
- ANSI Class 150 Flanges
- Copper Tubing and Brass Fittings

**Options (Add suffix letters to ZW206)**

**Function**

- C - 40XL2 Hydraulic Check with Isolation Valve
- L - SC1 Closing Speed Control (Standard on 6" or larger)
- O - SC1 Opening Speed Control

**Body**

- A - Angle Style Body
- R - Reduced Port Body

**Connections**

- G - IPS Grooved
- TH - NPT Threaded
- Y - ANSI Class 300 Flanges

**Main Valve Options**

- V - Viton Rubber Internals, Rated 180° (1-1/4" - 6")
- Z - ZPI Visual Position Indicator

**Pilot System**

- ST - Stainless Steel Tubing ("included with SP option, only replaces Copper Tubing")
- SP - All Stainless Steel Pilotry (replaces all brass fittings, pilot valve and copper tubing. "GL" Option included)
- SH - Stainless Steel Braided Hoses (only replaces Copper Tubing)
- NC - Normally Closed (energize to open) Main Valve, 120vac Solenoid
- NO - Normally Open (energize to close) Main Valve 120vac Solenoid
- 24NC - Normally Closed (energize to open) Main Valve, 24vac Solenoid
- 24NO - Normally Open (energize to close) Main Valve 24vac Solenoid
- NS - Non-Standard Solenoid specify Voltage/Frequency/AC/DC/ Operation
- MO - Manual Operator on Solenoid Valve (to control during power failure)
- W - Independent Operating Pressure
- F - Atmospheric Drain
- RV - Pilot Installed on reverse side

### Globe and Angle Main Valve Dimensions

DIM	FULL PORT	VALVE SIZE INCHES (mm)											
		1 1/4 (32)	1 1/2(38)	2 (50)	2 1/2(65)	3 (80)	4 (100)	6 (150)	8 (200)	10 (250)	12 (300)	14 (350)	16 (400)
A	Threaded	7 1/4	7 1/4	9 7/16	11	12 1/2							
	Class 150 Flange		8 1/2	9 3/8	11	12	15	20	25 3/8	29 3/4	34	39	41 3/8
	Class 300 Flange		9	10	11 5/8	13 1/4	15 5/8	21	26 7/16	31 1/8	35 1/2	40 1/2	43 1/2
	Grooved		8 1/2	9	11	12 1/2	15	20	25 3/8	29 3/4			
B	Diameter	5 5/8	5 5/8	6 3/4	8	9 3/16	11 11/16	15 3/4	20 1/8	23 11/16	27 1/2	31 3/4	34 1/2
C	Max.	5 3/4	5 3/4	6 3/16	7 3/8	8	10 3/16	12 5/16	15 9/16	17 5/8	20 3/16	22 13/16	25 7/8
D	Threaded/Grooved	1 3/8	1 3/8	1 3/4	2 1/8	2 9/16	3 7/16	5	5	5 13/16	6 3/4	8 7/8	8 13/16
	Class 150 Flange		2 1/2	3	3 1/2	3 3/4	4 1/2	5 1/2	6 3/4	8	9 1/2	10 1/2	11 3/4
	Class 300 Flange		3	3 1/4	3 3/4	4 1/8	5	6 1/4	7 1/2	8 3/4	10 1/4	11 1/2	12 3/4
E	NPT Body Tap	3/8	3/8	3/8	1/2	1/2	3/4	3/4	1	1	1	1	1
F	NPT Cvr. Plug Tap	1/2	1/2	1/2	1/2	1/2	3/4	3/4	1	1	1	1	1
G	NPT Cover Tap	3/8	3/8	3/8	1/2	1/2	3/4	3/4	1	1	1	1	1
H	Threaded	3 1/4	3 1/4	4 3/4	5 1/2	6 1/4							
	Class 150 Flange		4	4 3/4	5 1/2	6	7 1/2	10	12 11/16	14 7/8			
	Class 300 Flange		4 1/4	5	6	6 7/16	8	10 1/2	13 1/4	15 9/16			
	Grooved		4 7/16	4 3/4	5 1/2	6	7 1/2	10	12 11/16	14 7/8			
J	Threaded	1 15/16	1 15/16	3 1/4	4	4 1/2							
	Class 150 Flange		4	3 1/4	4	4	5	6	8	8 5/8			
	Class 300 Flange		4 1/4	3 1/2	4 5/16	4 7/16	5 5/16	6 1/2	8 1/2	9 5/16			
	Grooved		3 3/16	3 1/4	4	4 1/4	5	6	8	8 5/8			
Valve Stem Internal Thread		10-32	10-32	10-32	10-32	1/4-20	1/4-20	1/4-20	3/8-16	3/8-16	3/8-16	3/8-16	3/8-16
Stem Travel (in)		7/16	7/16	3/4	7/8	1	1 3/16	1 3/4	2 3/8	2 13/16	3 7/16	3 13/16	4 5/16
Approx. Wt. (lbs)		22	26	36	55	70	130	240	440	720	820	1200	1550

### Reduced Port Main Valve Dimensions

DIM		VALVE SIZE INCHES (mm)				
		3" (80)	4" (100)	6" (150)	8" (200)	10" (250)
A	Class 150 Flange	10 1/4	14	17 3/4	21 7/16	26
	Class 300 Flange	11	14 1/2	18 11/16	22 7/16	27 7/16
B	Dia	6 3/4	9 3/16	11 11/16	15 3/4	20 1/8
C	Max	6 3/8	8 7/16	12 5/16	13 1/4	16 3/4
D	Class 150 Flange	3 3/4	4 1/2	5 1/2	6 3/4	8
	Class 300 Flange	4 1/8	5	6 1/4	7 1/2	8 3/4
E	NPT Body Tap	3/8	1/2	3/4	3/4	1
F	NPT Cvr. Plug Tap	3/8	1/2	3/4	3/4	1
G	NPT Cvr. Tap	3/8	1/2	3/4	3/4	1
Valve Stem Internal Thread		10-32	1/4-20	1/4-20	3/8-16	3/8-16
Stem Travel (in)		3/4	1	1 1/5	1 3/4	2 3/8
Approx. Wt. (Lbs)		35	80	140	275	480

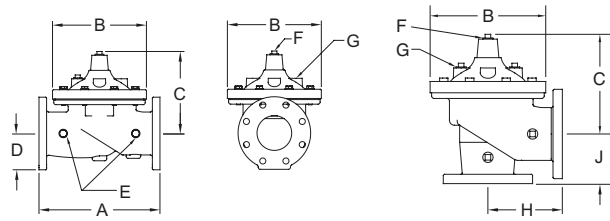

Globe Style Body

Angle Style Body

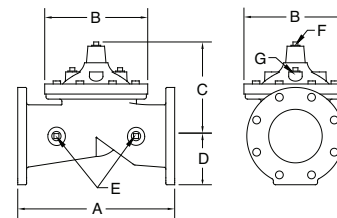

Reduced Port Body

### Pilot System Dimensions

PILOT SYSTEM DIMENSIONS		VALVE SIZE INCHES (mm)											
DIM		1-1/4 (32)	1-1/2 (40)	2" (50)	2-1/2" (65)	3" (80)	4" (100)	6" (150)	8" (200)	10" (250)	12" (300)	14" (350)	16" (400)
		Full Port Body	X Max. (inches)	8 1/8	8 1/8	8 1/8	8 1/8	8 5/8	13	13 3/16	15	16	20
Y Max. (inches)	4 1/8		4 1/4	4 1/4	5 1/4	5 1/4	5 13/16	7 7/8	10	12	14	16	17 1/2
Z Max. (inches)	7		6 7/8	7	7	7 1/2	11	12	14 1/4	15 1/2	18	20	21 1/2
Reduced Port Body	X Max. (inches)					8 1/8	8 5/8	13	13 3/16	15			
	Y Max. (inches)					4 1/4	5 1/4	5 13/16	7 7/8	10			
	Z Max. (inches)					7	7 1/2	11	12	14 1/4			
Angle Body	X Max. (inches)	8 1/2	8 1/2	8 1/2	8 1/2	9	13 1/2	13 1/2	15 1/2	16 1/2			
	Y Max. (inches)	5	5	5	5	5	5 13/16	7 7/8	10	12			
	Z Max. (inches)	7 1/2	7 1/2	7 1/2	7 1/2	8	11 1/2	12 1/2	15	16			

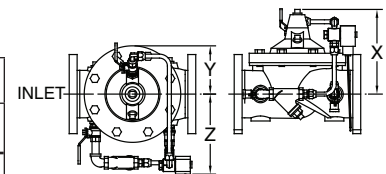

Globe Pilot System Dimensions

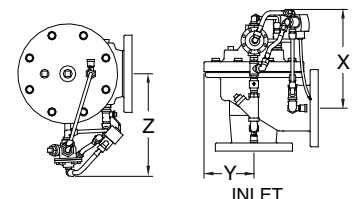

Angle Pilot System Dimensions

**Flow Characteristics**

Full Port Globe and Angle Valve size	inches (mm)	1 1/4 (32)	1 1/2 (40)	2 (50)	2 1/2 (65)	3 (80)	4 (100)	6 (150)	8 (200)	10 (250)	12 (300)	14 (350)	16 (400)
Reduced Port Globe Valve Size	inches (mm)			3 (80)		4 (100)	6 (150)	8 (200)	10 (250)				
Suggested Flow (GPM)	Max. Continuous	93	125	210	300	460	800	1800	3100	4900	7000	8400	11000
	Max Intermittent	120	160	260	375	600	1000	2250	4000	6150	8700	10500	13800
	Min. Continuous	10	10	15	20	30	50	115	200	300	435	530	690
Suggested Flow (Liters/sec)	Max. Continuous	6	8	13	19	29	50	113	195	309	550	665	870
	Max. Intermittent	7.6	10	16.4	23	37	62	142	246	388	440	530	95
	Min. Continuous	.6	.6	0.9	1.3	1.9	3.2	7.2	13	19	28	33	43

Suggested flow calculations are based on flow through Schedule 40 Pipe. Maximum Continuous flow is approx. 20 ft./sec (6.1 meters/sec) & Maximum Intermittent is approx. 25 ft./sec (7.6 meters/sec).

**Operation**

The Model ZW206 is supplied with an electrical-actuated pilot assembly. This pilot has two basic parts: 1) the solenoid, or coil, itself, and 2) the pilot valve that channels flow of the liquid being handled. These two parts combine to form a single unit called the "Solenoid Controlled Pilot".

Operating Sequence:

Assuming the use of a NORMALLY CLOSED (energized to open) 3-way Solenoid Pilot Valve:

- a) The sequence begins with the solenoid de-energized. The pilot connects inlet pressure to the main valve cover holding the main valve closed.
- b) When the solenoid is energized: the pilot valve switches allowing pressure in the cover to be vented downstream. This enables inlet pressure to open the main valve.
- c) When the solenoid is de-energized, the pilot valve returns to its original position, connecting the cover back to inlet pressure which closes the main valve. Pilot and valve are now ready for the next sequence.

**Typical Installation**

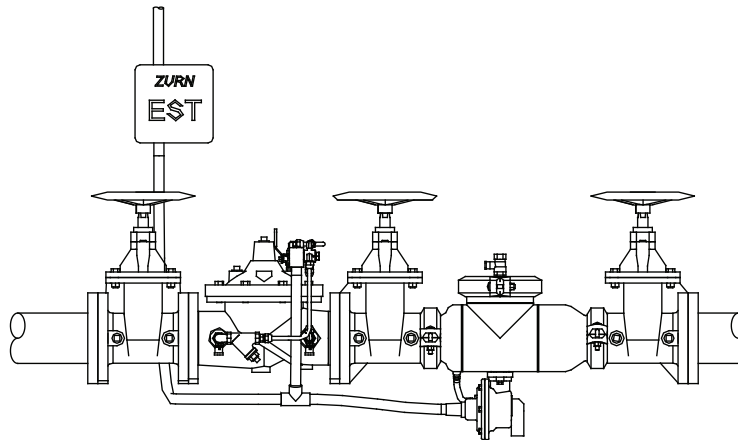

Model ZW206 w/ 375ASTMS (Shown)

**Specifications**

The Solenoid Control Valve shall be a single seated, line-pressure-operated, diaphragm-actuated, pilot-controlled globe or angle valve. The valve shall seal by means of a corrosion resistant seat and resilient, rectangular seat disc. These and other parts shall be replaceable in the field; all such service and adjustments to be possible without removing the valve from the line. The stem of the basic valve shall be guided top and bottom by integral bushings. The basic valve and its pilot control system shall contain no packing glands or stuffing boxes. The diaphragm shall not be used as a seating surface, nor shall pistons be used as an operating medium. All internal and external ferrous surfaces shall be coated with a high-quality, FDA Approved blue fusion epoxy coating. The valve shall be certified to NSF/ANSI Standard 61. The Solenoid Control Valve shall be a ZURN WILKINS Model ZW206.

Job Name \_\_\_\_\_ Contractor \_\_\_\_\_

Job Location \_\_\_\_\_ Engineer \_\_\_\_\_

### BODY MINIMUM FRICTION LOSS

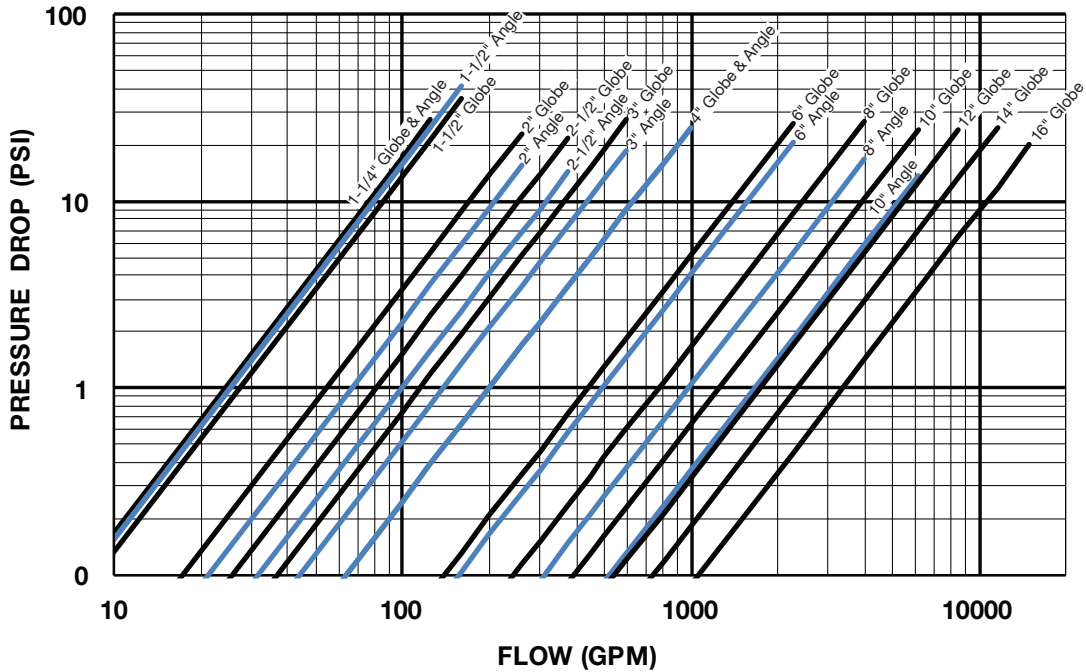

### PRESSURE REDUCTION LIMIT

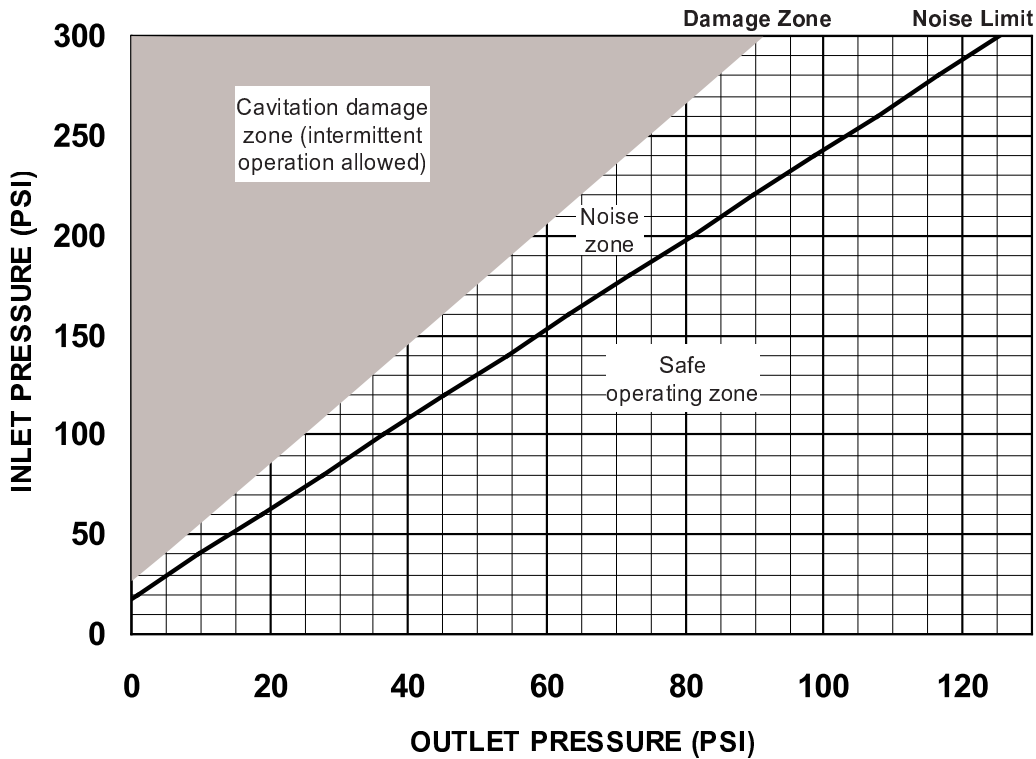

**Note:** If the valve is to be used for continuous flow, supply adequate back pressure to operate the valve below the "Damage Zone" shown on the "Pressure Reduction Limit" chart. If the valve discharges to atmosphere adequate back pressure is very important, contact Zurn Wilkins for assistance.