



Model ZW4000

Pressure-Tru™ Fire Hose Valve

Application

The Pressure-Tru™ ZW4000 Series Pressure Reducing Valve is listed as a standpipe valve for individual hose stations in CLASS I and CLASS III systems. Regulates pressure under both FLOW and NO-FLOW conditions.

Standards Compliance

- UL® Listed
- C-UL® Listed
- NYC MEA 325-06-E
- City of Los Angeles Approved

Material

Castings/internals Cast bronze ASTM B 584
Elastomers Buna Nitrile (FDA approved)
EPDM (FDA approved)



ZW4000



ZW4000G

Features

Sizes: 2 1/2"
Maximum inlet pressure 400 psi
Inlet connection: (FNPT) or ANSI B1.20.1
(Grooved) AWWA C606
Outlet connection: Male Hose (NH) NFPA 1963
Factory Set
Tapped and plugged inlet and outlet for pressure gauge.

Options

- (Suffixes can be combined)
- ZW4000 - angle type valve
 - IL - in-line (globe type) valve
 - G - with grooved inlet connection
 - SF - with San Francisco hose thread (3")
 - ST - with specified hose thread
 - CC - with cap and chain
 - CH - with chrome finish

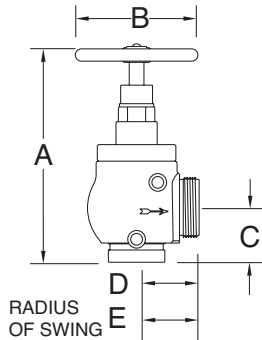

ZW4000G

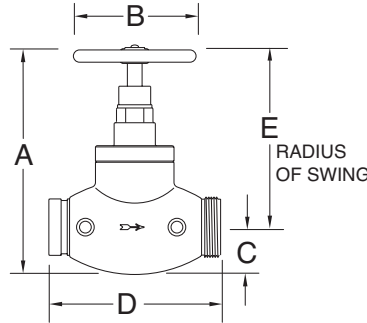

ZW4000ILG

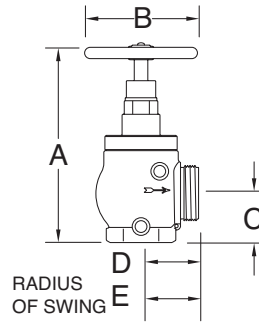

ZW4000

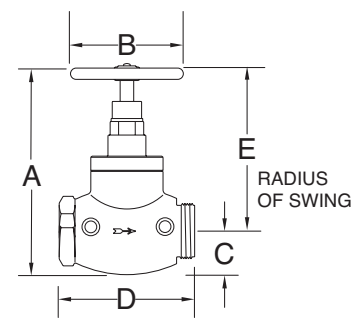

ZW4000IL

Dimensions & Weights (do not include pkg.)

MODEL	DIMENSIONS (approximate)													
	A OPEN		A CLOSED		B		C		D		E		WEIGHT	
	in.	mm	in.	mm	in.	mm	in.	mm	in.	mm	in.	mm	lbs	kg
ZW4000	10 7/8	276	10	254	6 1/4	159	2 3/4	70	3 3/16	81	3 1/2	89	19	8.6
ZW4000IL	11 1/2	292	10 1/2	267	6 1/4	159	2 3/8	60	7 1/2	191	8 3/16	208	23	10.4
ZW4000G	11 5/16	287	10 7/16	265	6 1/4	159	3 5/16	84	3 3/16	81	3 1/2	89	18	8.1
ZW4000ILG	11 1/2	292	10 1/2	267	6 1/4	159	2 3/8	60	8 3/4	222	8 3/16	208	23	10.4
ZW4000SF	10 7/8	276	10	254	6 1/4	159	2 3/4	70	3 15/16	100	3 1/2	89	19	8.6

Residual Pressure Charts

For Pressure-Tru® 2 1/2" Models: ZW4000, ZW4000G, ZW4004 & ZW4004G

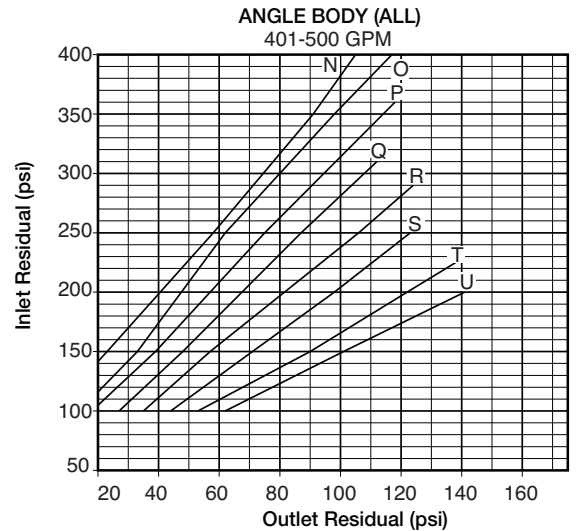
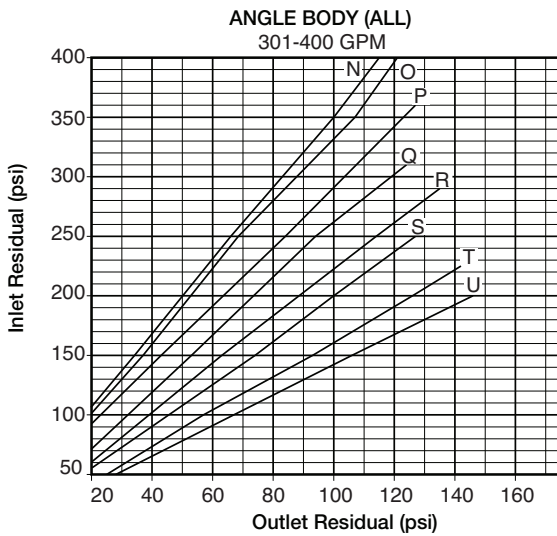
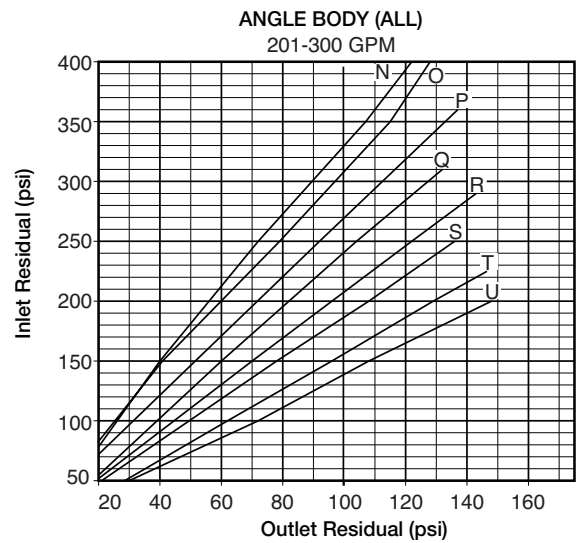
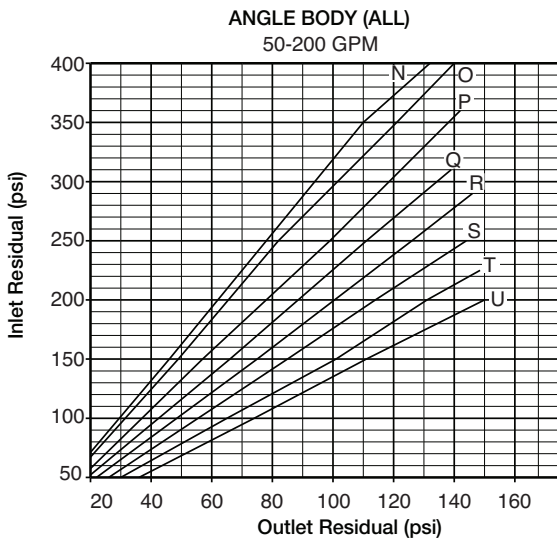

Choosing The Correct Settings

In designing a sprinkler system, a minimum of 20 psi pressure differential (the difference between the inlet static pressure and the valve outlet set static pressure) is recommended to assure a well regulated and efficient system. In choosing the correct setting for the Pressure-Tru® valve, refer to the Residual Pressure Charts, Static Pressure Chart and the following procedures:

1. Determine the demand in gallons per minute required downstream of the valve.
2. Determine the standpipe residual or "flow pressure" at the valve inlet.
3. Locate the appropriate flow chart based on GPM required and body style.
4. Locate the inlet residual pressure on the vertical axis of the chart and draw a horizontal line from this pressure across the chart.
5. Locate the desired valve outlet residual pressure on the horizontal axis of the chart and draw a vertical line from this pressure.
6. The curve nearest the intersection of the two lines drawn is the appropriate type for the valve.
7. To determine the static outlet pressure, locate the static chart. Determine the valve inlet static pressure shown on the vertical axis and draw a horizontal line from that pressure to the appropriate curve determined above, then draw a vertical line down to the horizontal axis and read the static outlet pressure.

Maximum Rated Inlet Pressure

Maximum inlet pressure, to assure a maximum outlet pressure of 175 psi. Inlet side of valves can be safely tested up to 400 PSI during system hydrostatic leak test.

Bonnet Type	Max Inlet Pressure psi (kpa)	
N	400	(2750)
O	400	(2750)
P	360	(2475)
Q	310	(2125)
R	290	(2000)
S	250	(1725)
T	225	(1550)
U	200	(1375)

Residual Pressure Charts

For Pressure-Tru® 2 1/2" Models: ZW4000IL & ZW4004IL

INLINE BODY (NPT)
50-100 GPM

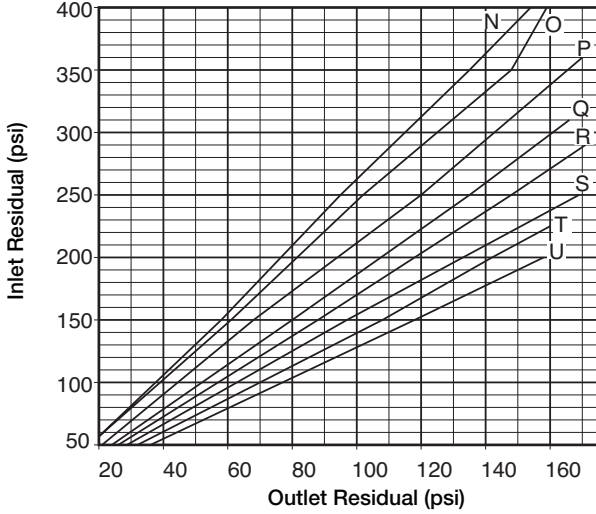

INLINE BODY (NPT)
101-200 GPM

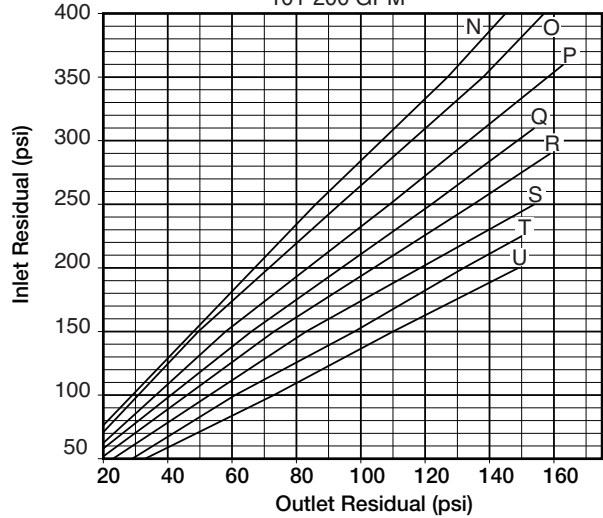

INLINE BODY (NPT)
201-300 GPM

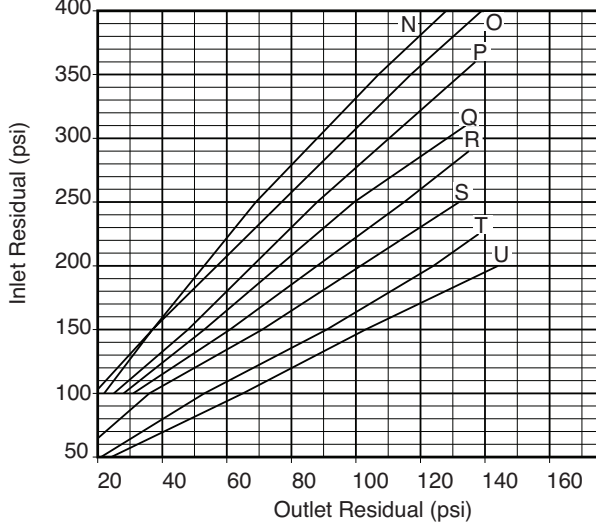

INLINE BODY (NPT)
301-400 GPM

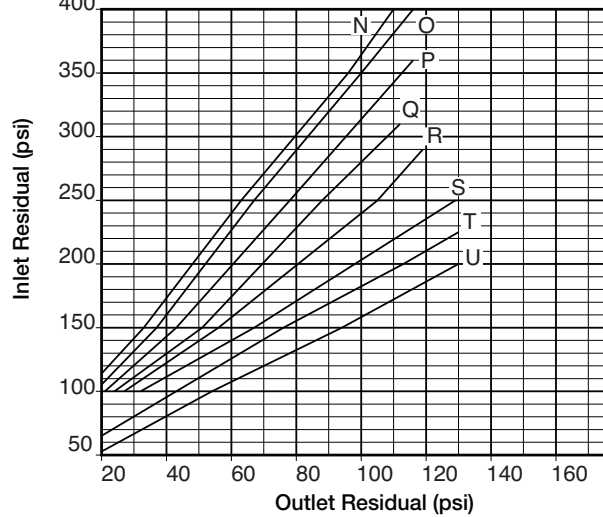

INLINE BODY (NPT)
401-500 GPM

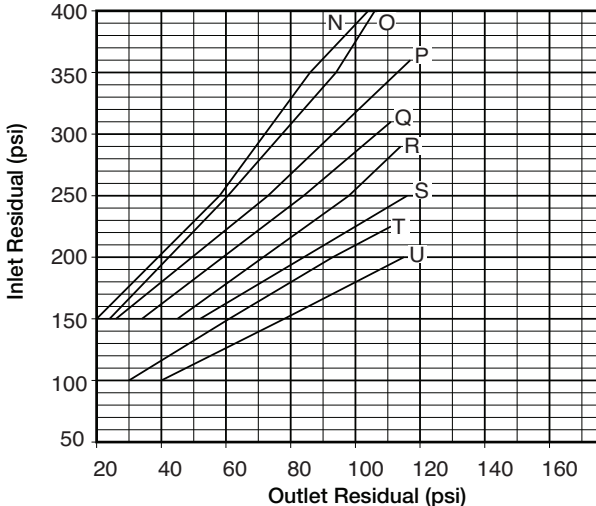

ANGLE & INLINE BODIES (ALL)
STATIC CHART

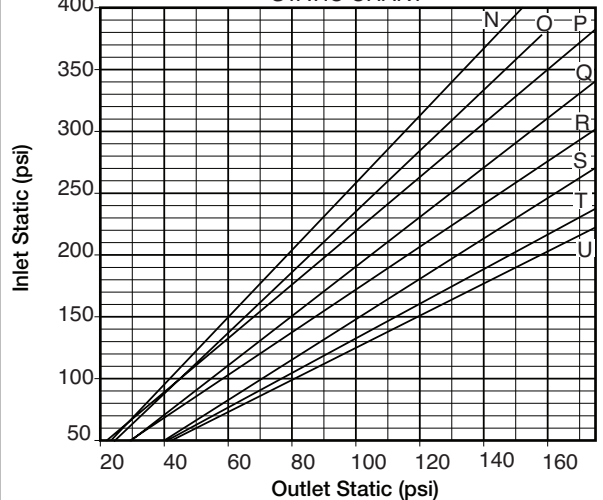

Residual Pressure Charts

For Pressure-Tru® 2 1/2" Models: ZW4000ILG & ZW4004ILG

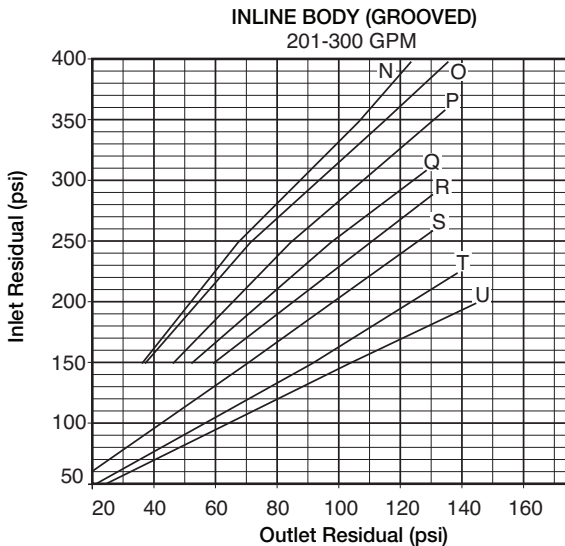
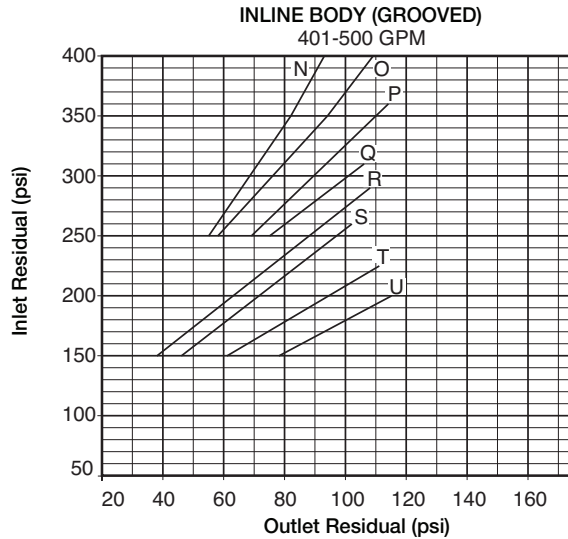
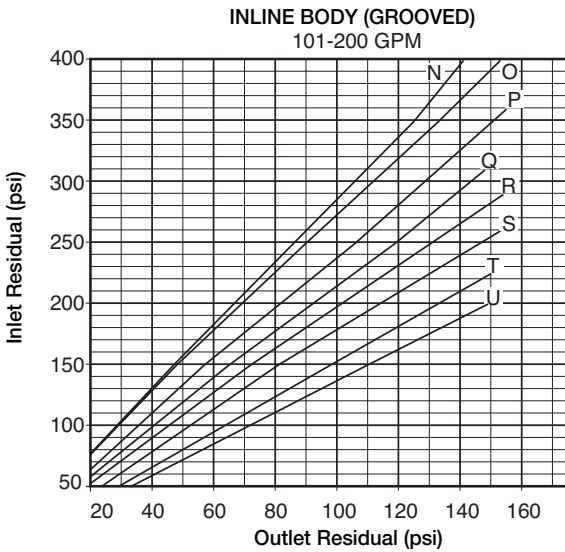
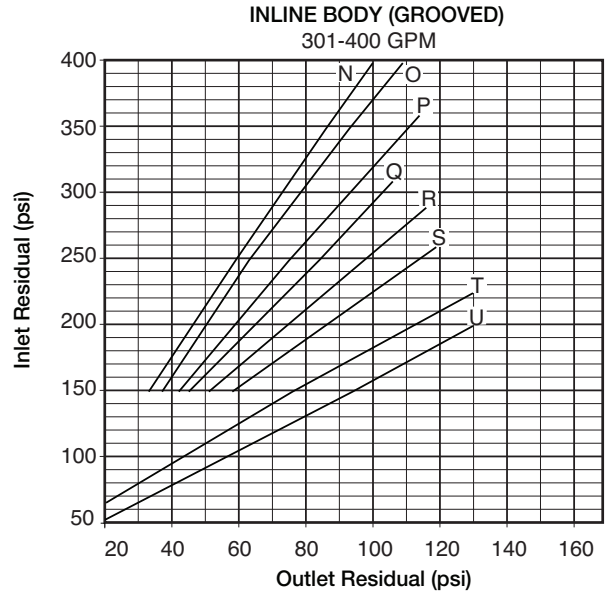
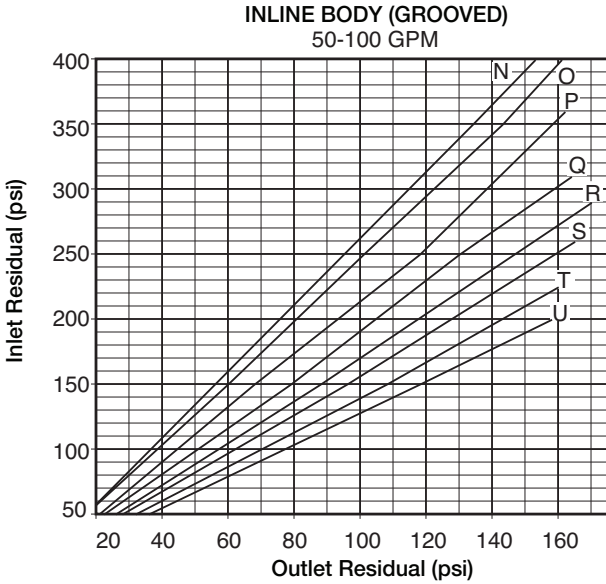

Proper performance is dependent upon licensed, qualified personnel performing regular, periodic testing according to ZURN WILKINS' specifications and prevailing governmental & industry standards and codes and upon following these installation instructions. Failure to do so releases ZURN WILKINS of any liability that it might otherwise have with respect to that device. Such failure could also result in an improperly functioning device.